



Bridgelux® Vesta® Series Dim-To-Warm 15mm Array

Product Data Sheet DS159



Introduction

Vesta® Series



Vesta® Series Dim-To-Warm Array products deliver adaptable light in a cost-effective, solid state lighting package. Vesta Series products tap into the powerful mediums of light and color to influence experience, well-being, and human emotion. They allow fixture manufacturers to simulate the familiar glow and dimming of incandescent lamps. This high flux density light source is designed to support a wide range of high quality, low cost directional luminaires and replacement lamps for commercial and residential applications.

Lighting system designs incorporating these LED arrays deliver comparable performance to 150 Watt incandescent-based luminaires, while increasing system level efficacy and prolonging service life. Typical luminaire and lamp types appropriate for this family include replacement lamps, down lights, wall packs and accent, spot and track lights.

Features

- Dimming range from 2700K to 1800K and 3000K to 1800K
- Efficacy of up to 115 lm/W typical at 3000K 90 CRI
- Uniform, high quality illumination
- Minimum 90 and 95 CRI options
- More energy efficient than incandescent, halogen and fluorescent lamps
- Industry standardized dimensions
- Flux packages up to 3725 lumens typical

Benefits

- Superior color dimming transition
- Compact system design resulting from high lumen density
- High quality, true color reproduction
- Enhanced optical control
- Uniform, consistent white light
- Lower operating costs
- Reduced maintenance costs

Contents

| | |
|----------------------------|---------|
| Product Feature Map | 2 |
| Product Nomenclature | 2 |
| Product Selection Guide | 3 |
| Electrical Characteristics | 4 |
| Absolute Maximum Ratings | 5 |
| Performance Curves | 6 - 7 |
| Typical Radiation Pattern | 8 |
| Typical Color Spectrum | 9 |
| Mechanical Dimensions | 10 |
| Color Binning Information | 11 - 12 |
| Packaging and Labeling | 13 |
| Design Resources | 14 |
| Precautions | 14 |
| Disclaimers | 14 |
| About Bridgelux | 15 |

Product Feature Map

Bridgelux arrays are fully engineered devices that provide consistent thermal and optical performance on an engineered mechanical platform. The arrays incorporate several features to simplify design integration and assembly. Please visit www.bridgelux.com for more information on the Vesta Series family of products.

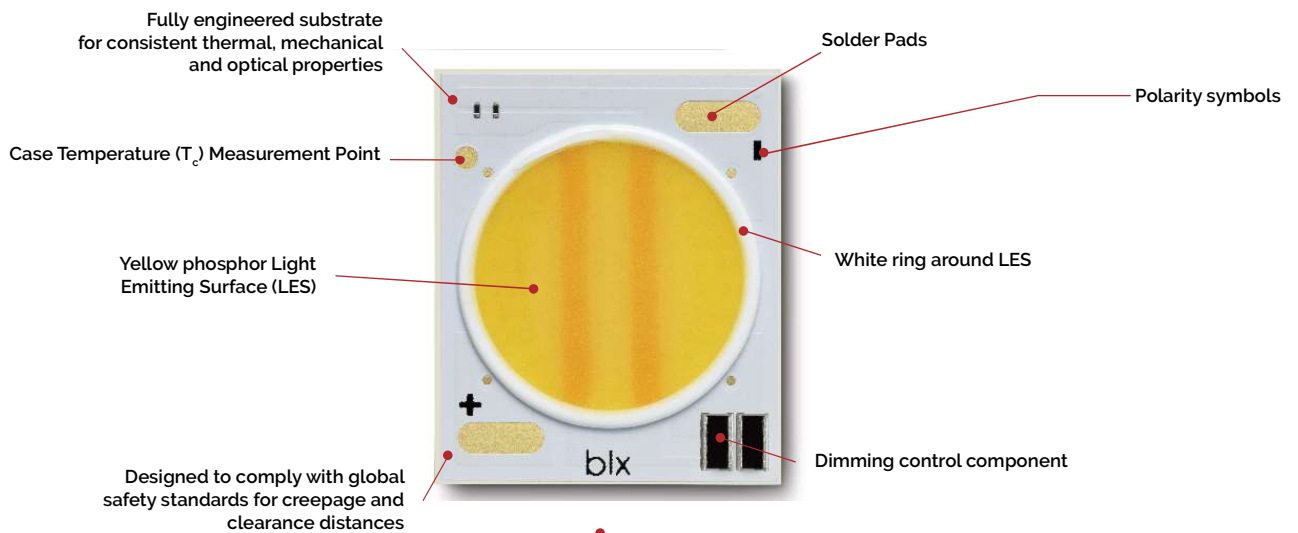

Note: Part number and lot codes are scribed on back of array

Product Nomenclature

The part number designation for Bridgelux Vesta Series arrays is explained as follows:

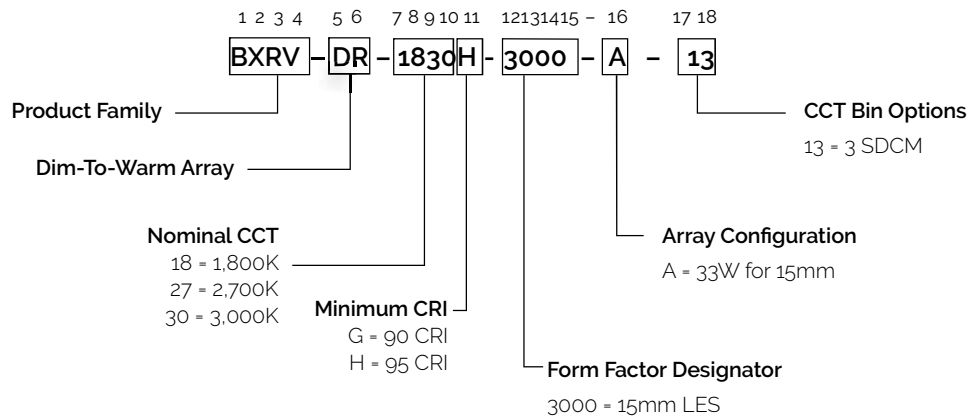

Product Selection Guide

The following product configurations are available:

Table 1: Selection Guide, Measurement Data

| Part Number | Nominal CCT ¹ T _c =25°C (K) | CRI ² | Drive Current (mA) | Typical V _f T _c =25°C (V) | Typical Power T _c =25°C (W) | Typical Efficacy T _c =25°C (lm/W) | Typical Pulsed Flux ^{3, 4, 5} T _c =25°C (lm) | Minimum Pulsed Flux ⁶ T _c =25°C (lm) | Typical DC Flux ^{7, 8} T _c =85°C (lm) |
|-------------------------|---|------------------|-----------------------|---|--|--|--|--|---|
| BXRV-DR-1827G-3000-A-13 | 2700 | 90 | 950 | 34.1 | 32.4 | 105 | 3401 | 3061 | 2847 |
| | 1800 | 90 | 20 | 26.4 | 0.5 | 88 | 46 | 42 | 39 |
| BXRV-DR-1827H-3000-A-13 | 2700 | 95 | 950 | 34.1 | 32.4 | 83 | 2689 | 2420 | 2251 |
| | 1800 | 95 | 20 | 26.4 | 0.5 | 73 | 39 | 35 | 32 |
| BXRV-DR-1830G-3000-A-13 | 3000 | 90 | 950 | 34.1 | 32.4 | 115 | 3725 | 3353 | 3118 |
| | 1800 | 90 | 20 | 26.4 | 0.5 | 104 | 55 | 49 | 46 |
| BXRV-DR-1830H-3000-A-13 | 3000 | 95 | 950 | 34.1 | 32.4 | 102 | 3300 | 2970 | 3000 |
| | 1800 | 95 | 20 | 26.4 | 0.5 | 89 | 47 | 42 | 43 |

Notes for Table 1:

- Nominal CCT as defined by ANSI C78.377-2011.
- CRI Values are minimums. Minimum R_g value for 90 CRI products is 50. Minimum R_g value for 95 CRI products is 85, Bridgelux maintains a ±3 tolerance on all CRI and R_g values.
- Products tested under pulsed condition (10ms pulse width) at nominal test current where T_j (junction temperature) = T_c (case temperature) = 25°C.
- Typical performance values are provided as a reference only and are not a guarantee of performance.
- Bridgelux maintains a ±7% tolerance on flux measurements.
- Minimum flux values at the nominal test current are guaranteed by 100% test.
- Typical stabilized DC performance values are provided as reference only and are not a guarantee of performance.
- Typical performance is estimated based on operation under DC (direct current) with LED array mounted onto a heat sink with thermal interface material and the case temperature maintained at 85°C. Based on Bridgelux test setup, values may vary depending on the thermal design of the luminaire and/or the exposed environment to which the product is subjected.

Electrical Characteristics

Table 2: Electrical Characteristics

| Part Number | Drive Current (mA) | Forward Voltage Pulsed, $T_c = 25^\circ\text{C}$ (V) ^{1, 2, 3, 7} | | | Typical Coefficient of Forward Voltage $\Delta V_f / \Delta T_c$ (mV/ $^\circ\text{C}$) | Typical Thermal Resistance Junction to Case ^{4, 5} R_{j-c} ($^\circ\text{C}/\text{W}$) | Driver Selection Voltages ⁶ (V) | |
|------------------------|--------------------|--|---------|---------|--|---|--|---|
| | | Minimum | Typical | Maximum | | | V_f Min. Hot $T_c = 105^\circ\text{C}$ (V) | V_f Max. Cold $T_c = -40^\circ\text{C}$ (V) |
| BXRV-DR-xxxx-3000-A-13 | 950 | 30.9 | 34.1 | 37.3 | -15.0 | 0.15 | 29.7 | 38.3 |
| | 1050 | 31.3 | 34.5 | 37.7 | -15.0 | 0.16 | 30.1 | 38.7 |

Notes for Table 2:

- Parts are tested in pulsed conditions, $T_c = 25^\circ\text{C}$. Pulse width is 10ms.
- Voltage minimum and maximum are provided for reference only and are not a guarantee of performance.
- Bridgelux maintains a tester tolerance of $\pm 0.10\text{V}$ on forward voltage measurements.
- Typical coefficient of forward voltage tolerance is $\pm 0.1\text{mV}$ for nominal current.
- Thermal resistance value was calculated using total electrical input power; optical power was not subtracted from input power. The thermal interface material used during testing is not included in the thermal resistance value.
- V_f min hot and max cold values are provided as reference only and are not guaranteed by test. These values are provided to aid in driver design and selection over the operating range of the product.
- This product has been designed and manufactured per IEC 62031:2014. This product has passed dielectric withstand voltage testing at 500 V. The working voltage designated for the insulation is 45V d.c. The maximum allowable voltage across the array must be determined in the end product application.

Absolute Maximum Ratings

Table 3: Maximum Ratings

| Parameter | Maximum Rating |
|---|--|
| LED Junction Temperature (T_j) | 125°C |
| Storage Temperature | -40°C to +105°C |
| Operating Case Temperature ¹ (T_c) | 105°C |
| Soldering Temperature ² | 350°C or lower for a maximum of 10 seconds |
| Maximum Drive Current ³ | 1050mA |
| Maximum Peak Pulsed Drive Current ⁴ | 1500mA |
| Maximum Reverse Voltage ⁵ | -60V |

Notes for Table 3:

1. For IEC 62717 requirement, please contact Bridgelux Sales Support.
2. See Bridgelux Application Note AN101 "Handling and Assembly of LED Arrays" for more information.
3. Please refer to Figures 7 for drive current derating curves.
4. Bridgelux recommends a maximum duty cycle of 10% and pulse width of 20ms when operating LED arrays at the maximum peak pulsed current specified. Maximum peak pulsed currents indicate values where the LED array can be driven without catastrophic failures.
5. Light emitting diodes are not designed to be driven in reverse voltage and will not produce light under this condition. Maximum rating provided for reference only.

Performance Curves

Figure 1: Vesta Dim-to-Warm 15mm 33W
Forward Voltage vs. Forward Current, $T_c = 25^\circ\text{C}$

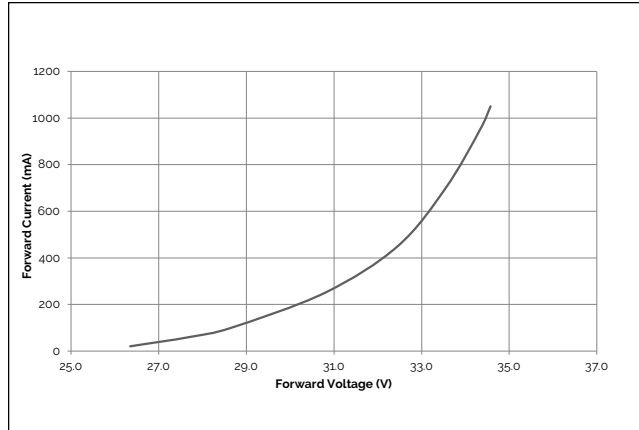

Figure 2: Vesta Dim-to-Warm 15mm 33W
CCT vs. Forward Current

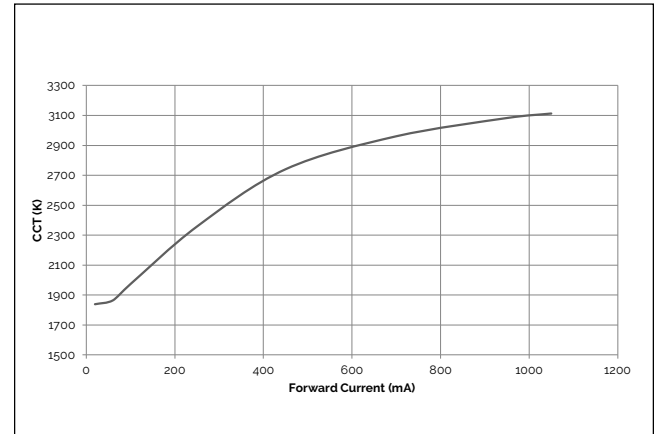

Figure 3: Vesta Dim-to-Warm 15mm 33W
Relative LOP vs. Drive Current, $T_c = 25^\circ\text{C}$

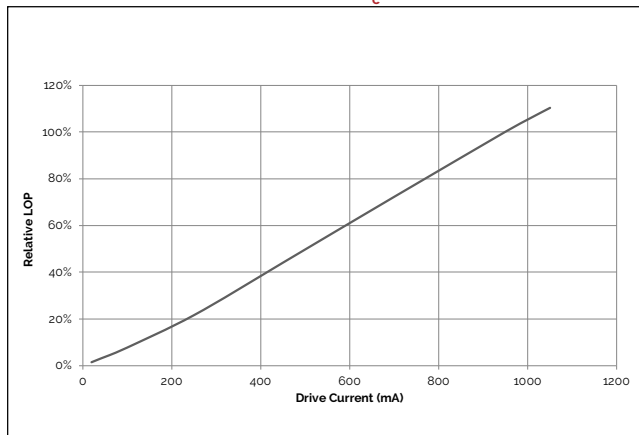

Figure 4: Vesta Dim-to-Warm 15mm 33W
Color Shift vs. Forward Current 2700K-1800K

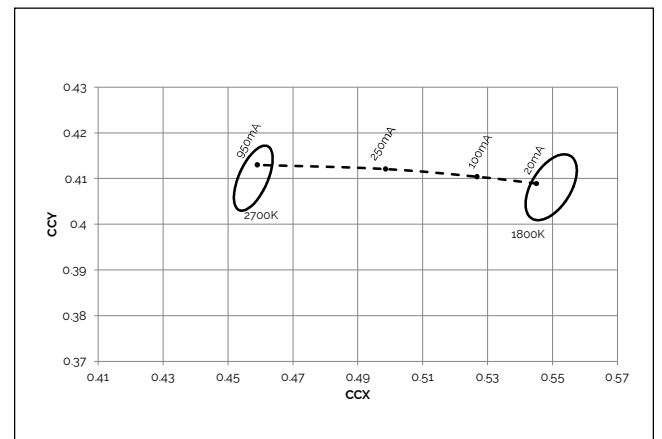

Figure 5: Vesta Dim-to-Warm 15mm 33W
Relative Flux vs. Case Temperature

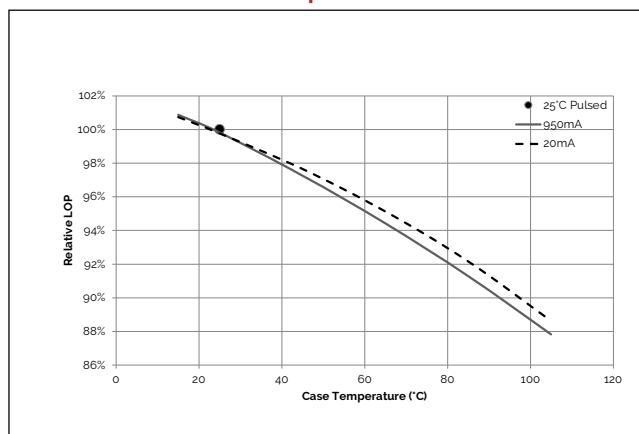
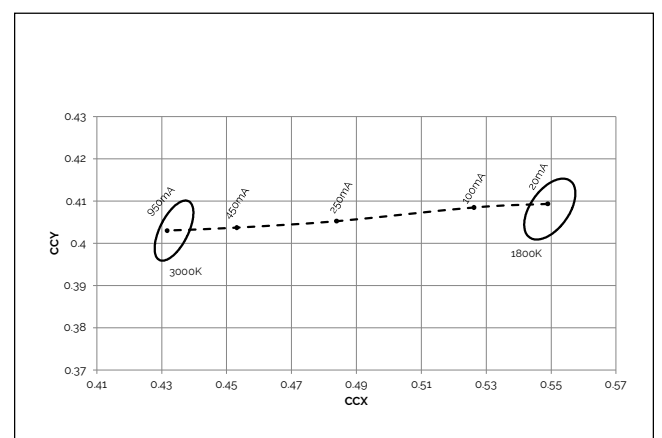
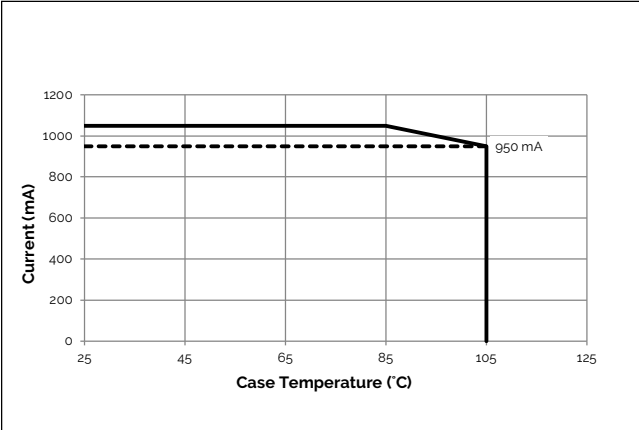

Figure 6: Vesta Dim-to-Warm 15mm 33W
Color Shift vs. Forward Current 3000K-1800K



Performance Curves

Figure 7: Vesta Dim-to-Warm 15mm 33W Derating Curve



Typical Radiation Pattern

Figure 8: Typical Spatial Radiation Pattern

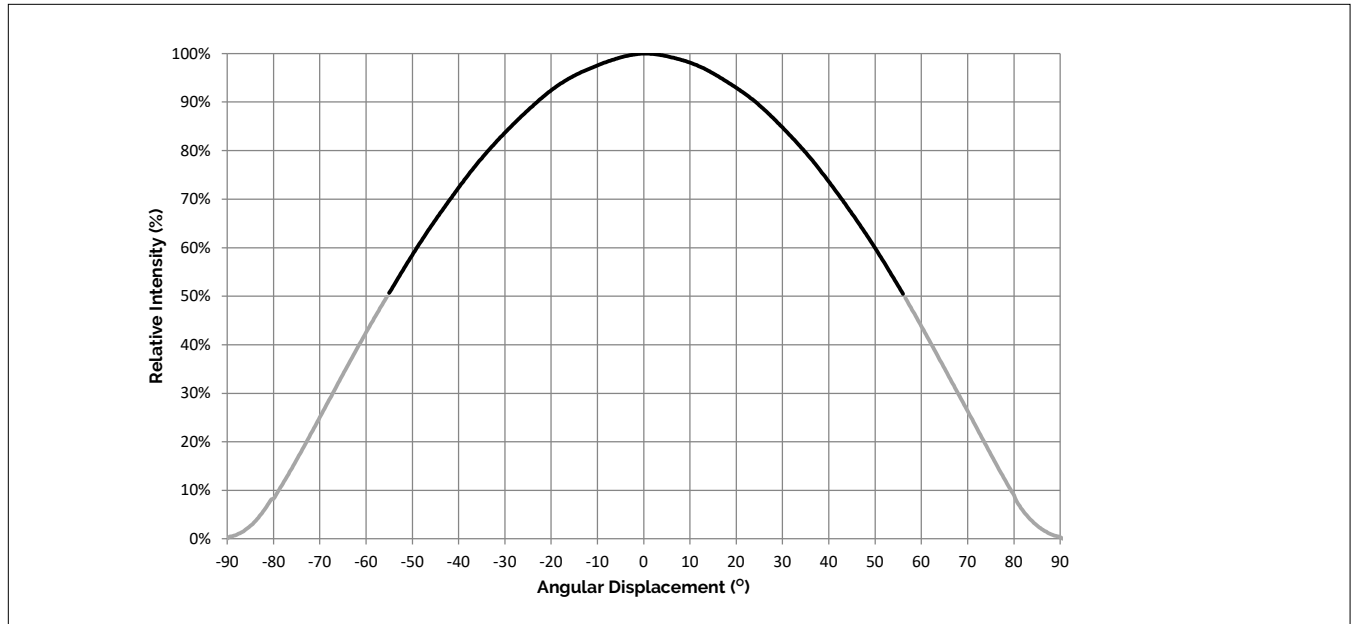

Notes for Figure 8:

1. Typical viewing angle is 110° .
2. The viewing angle is defined as the off axis angle from the centerline where I_v is $\frac{1}{2}$ of the peak value.

Figure 9: Typical Polar Radiation Pattern

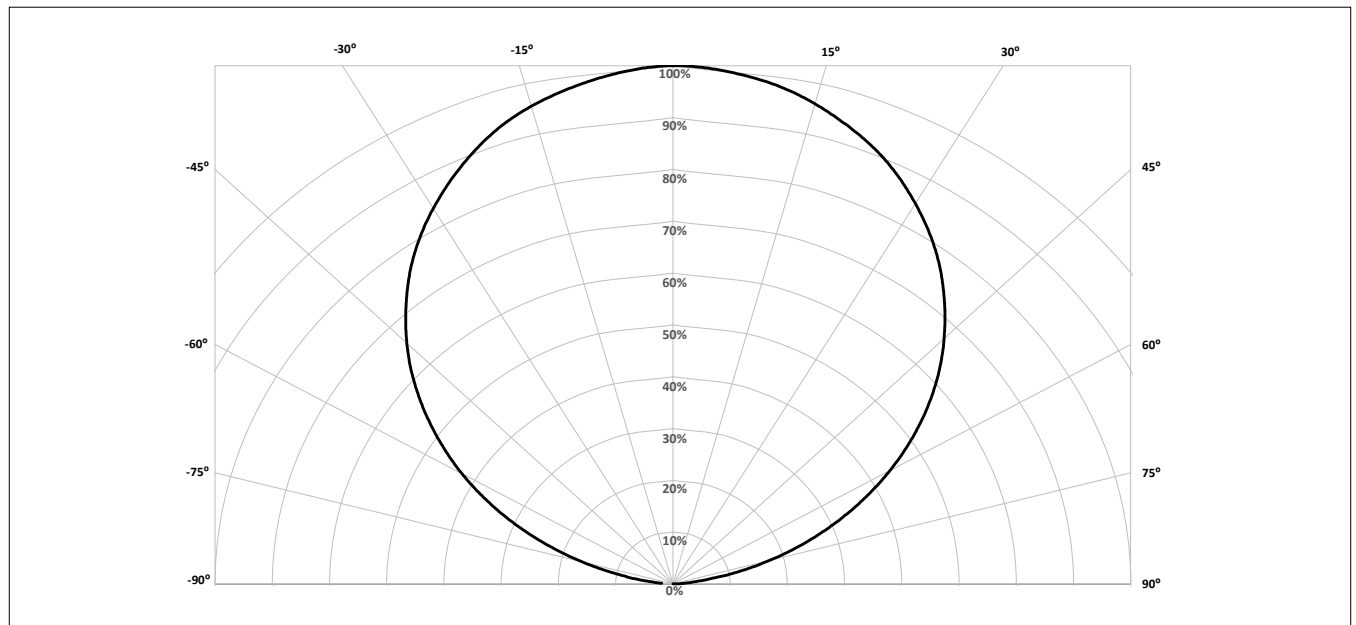

Typical Color Spectrum

Figure 10: Typical Color Spectrum

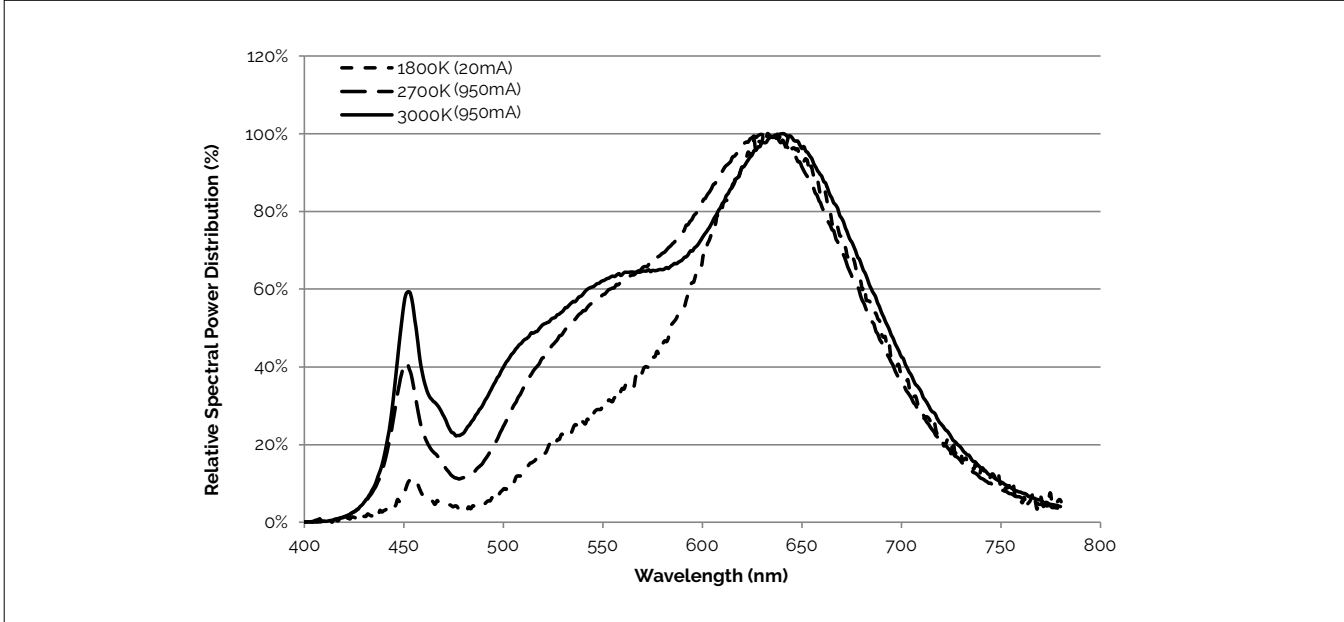

Note for Figure 10:

- 1. Color spectra measured at nominal current for $T_j = T_c = 25^\circ\text{C}$.

Mechanical Dimensions

Figure 11: Drawing for Vesta Series Dim-To-Warm 15mm Array

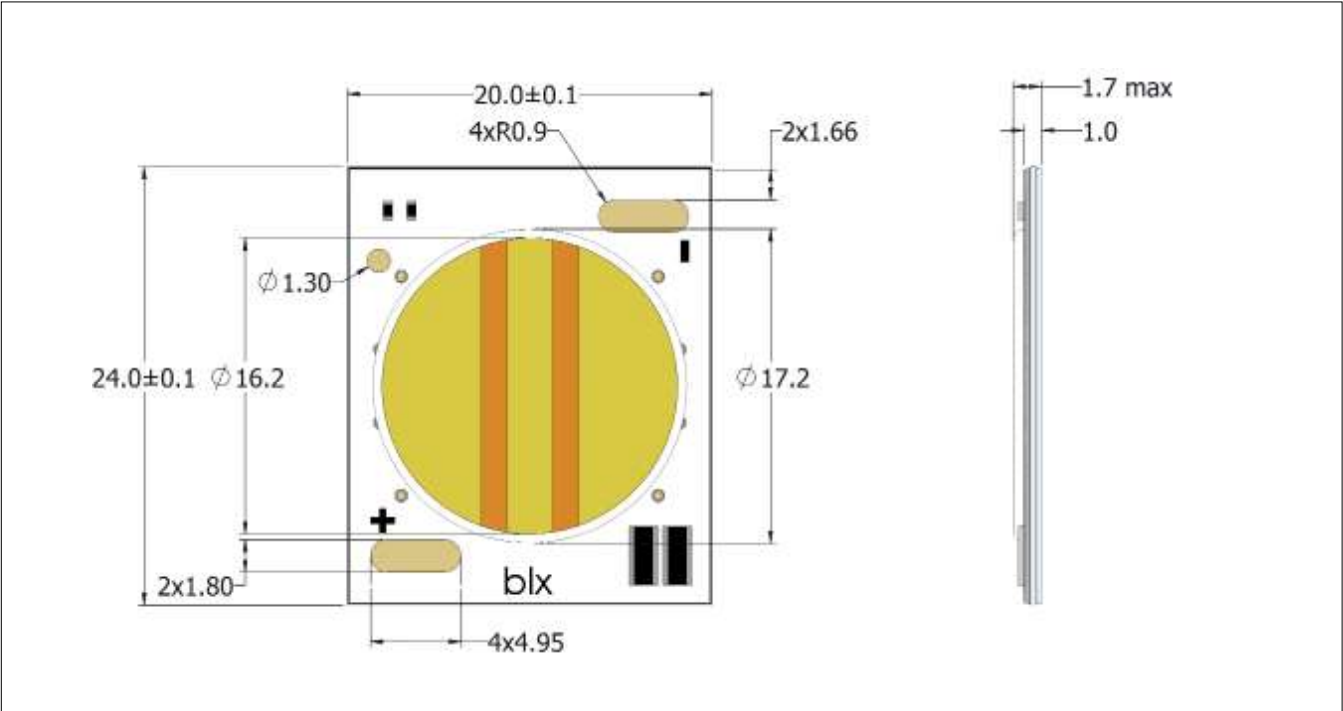

Notes for Figure 11:

1. Solder pads are labeled "+" to denote positive polarity and "-" to denote negative polarity.
2. Drawing is not to scale.
3. Drawing dimensions are in millimeters.
4. Unless otherwise specified, tolerances are $\pm 0.10\text{mm}$.
5. The optical center of the LED array is nominally defined by the mechanical center of the array. The light emitting surface (LES) is centered on the mechanical center of the array to a tolerance of $\pm 0.2\text{ mm}$
6. Bridgelux maintains a flatness of 0.1 mm across the mounting surface of the array. Refer to Application Notes for product handling, mounting and heat sink recommendations.

Color Binning Information

Figure 12: Graph of Warm White Test Bins in xy Color Space, $T_c = 25^\circ\text{C}$

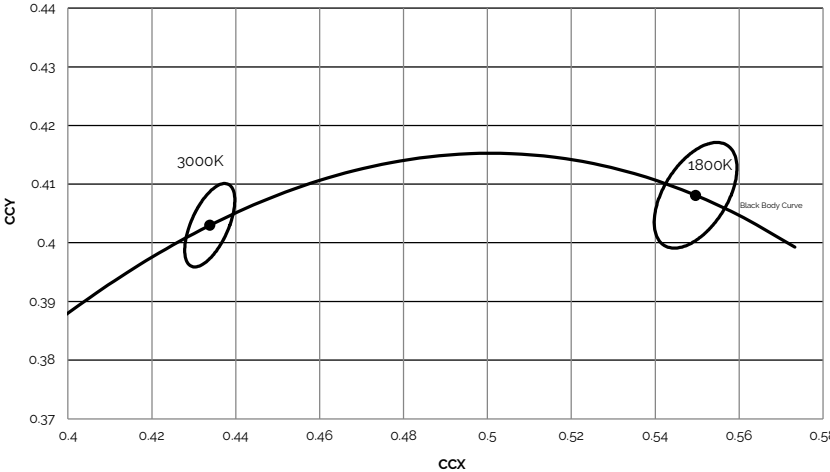
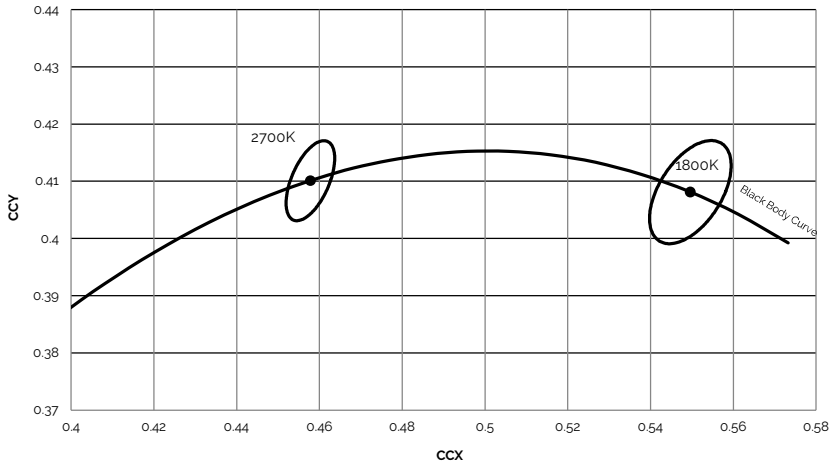

Note for Figure 12: Pulsed Test Conditions, $T_c = 25^\circ\text{C}$

Color Binning Information

Table 4: McAdam ellipse CCT color bin definitions for product operating at $T_c = 25^\circ\text{C}$

| CCT | Center Point | Bin Size | Axis a | Axis b | Rotation Angle |
|-------|-----------------------|----------|---------|---------|----------------|
| 1800K | x=0.5496 y=0.4081 | 5 SDCM | 0.00655 | 0.01164 | 130.00° |
| 2700K | x=0.4578 y= 0.4101 | 3 SDCM | 0.00810 | 0.00420 | 53.70° |
| 3000K | x=0.4338 y=0.4030 | 3 SDCM | 0.00834 | 0.00408 | 53.22° |

Notes for table 4:

1. The x,y center points are the center points of the respective ANSI bins in the CIE 1931 xy Color Space
2. Products are binned at $T_c=25^\circ\text{C}$
3. Bridgelux maintains a tolerance of ± 0.007 on x and y color coordinates in the CIE 1931 Color Space

Figure 13: Definition of the McAdam ellipse

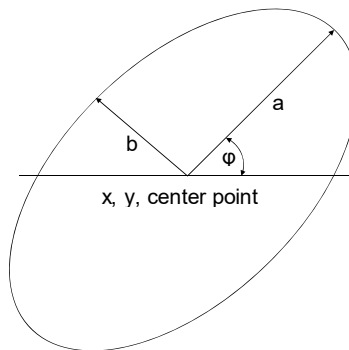

Packaging and Labeling

Figure 14: Vesta Series Dim-To-Warm 15mm Packaging and Labeling

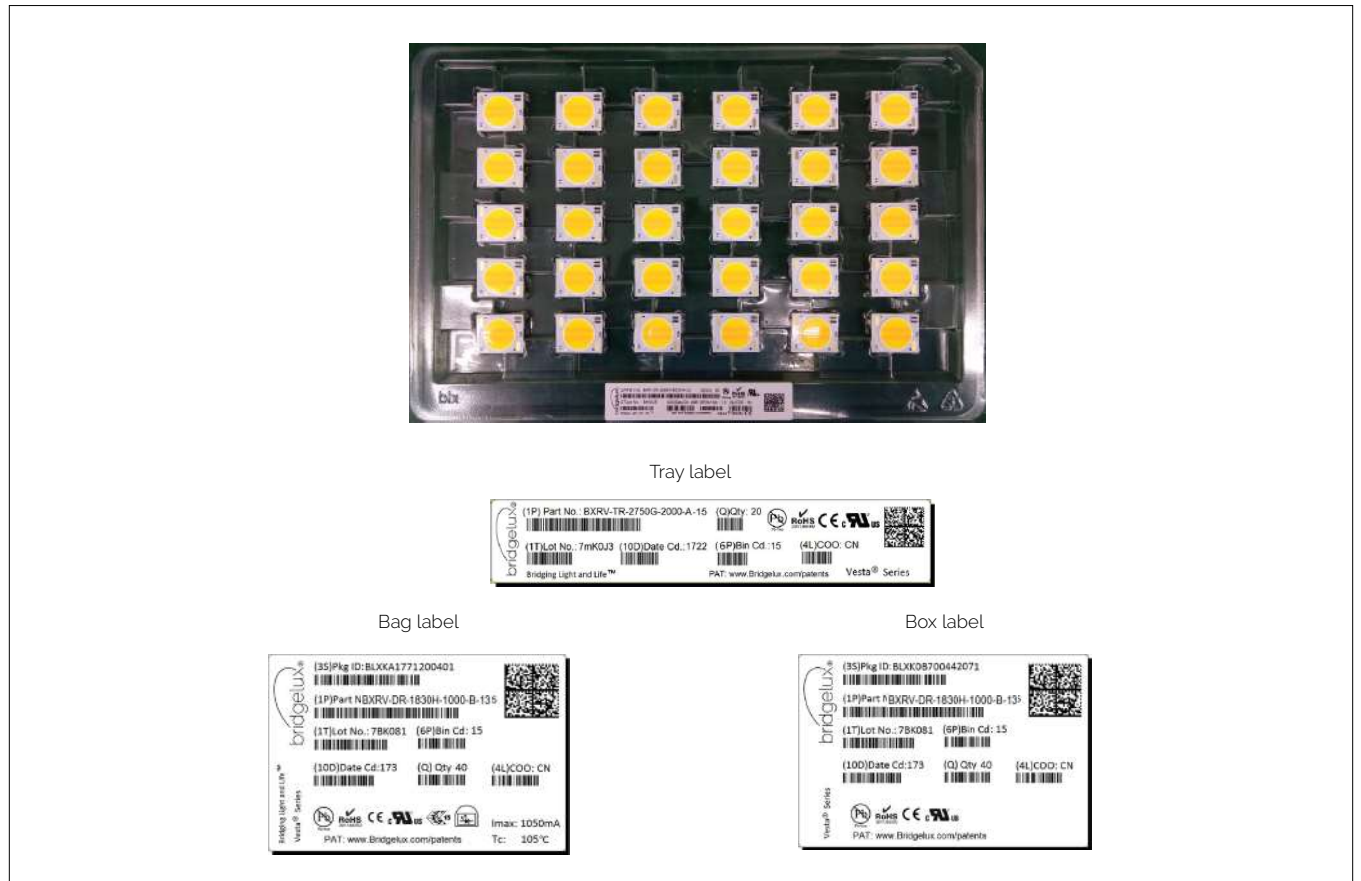

Notes for Figure 14:

1. Each tray holds 30 Vesta Series Dim-To-Warm 15mm arrays.
2. Eight trays are sealed in an anti-static bag. One such bag is placed in a box and shipped. Depending on quantities ordered, a bigger shipping box, containing more boxes will be used to ship products.
3. Each bag and box is to be labeled as shown above.
4. Dimensions for each tray are 200 (W) x 12(H) x 300 (L) mm. Dimensions for the anti-static bag are 440 (W) x 350mm (L) x 0.1 mm (T) mm and that of a shipping box are 350 x 245 x 67 mm.

Figure 15: Product Labeling

Bridgelux arrays have laser markings on the back side of the substrate to help with product identification. In addition to the product identification markings, Bridgelux arrays also contain markings for internal Bridgelux manufacturing use only. The image below shows which markings are for customer use and which ones are for Bridgelux internal use only. The Bridgelux internal manufacturing markings are subject to change without notice, however these will not impact the form, function or performance of the array.



Design Resources

Application Notes

Bridgelux has developed a comprehensive set of application notes and design resources to assist customers in successfully designing with the Vesta Series product family of LED array products. Please see Bridgelux Application Note, AN101 for more information. For a list of resources under development, visit www.bridgelux.com.

Optical Source Models

Optical source models and ray set files are available for all Bridgelux products. For a list of available formats, visit www.bridgelux.com.

3D CAD Models

Three dimensional CAD models depicting the product outline of all Bridgelux Vesta Series LED arrays are available in both IGES and STEP formats. Please contact your Bridgelux sales representative for assistance.

LM80

LM80 testing has been completed and the LM80 report is now available. Please contact your Bridgelux sales representative for LM-80 report.

Precautions

CAUTION: CHEMICAL EXPOSURE HAZARD

Exposure to some chemicals commonly used in luminaire manufacturing and assembly can cause damage to the LED array. Please consult Bridgelux Application Note, AN101 for additional information.

CAUTION: EYE SAFETY

Eye safety classification for the use of Bridgelux Vesta Series is in accordance with IEC/TR62778: Application of IEC 62471 for the assessment of blue light hazard to light sources and luminaires. Vesta Series Dim-To-Warm arrays are classified as Risk Group 1 when operated at or below the maximum drive current. Please use appropriate precautions. It is important that employees working with LEDs are trained to use them safely.

CAUTION: RISK OF BURN

Do not touch the Vesta Series LED array during operation. Allow the array to cool for a sufficient period of time before handling. The Vesta Series LED array may reach elevated temperatures such that could burn skin when touched.

CAUTION

CONTACT WITH LIGHT EMITTING SURFACE (LES)

Avoid any contact with the LES and resistors. Do not touch the LES or resistors of the LED array or apply stress to the LES (yellow phosphor resin area). Contact may cause damage to the LED array.

Optics and reflectors must not be mounted in contact with the LES (yellow phosphor resin area). Optical devices may be mounted on the top surface of the Vesta Series LED array. Use the mechanical features of the LED array housing and edges to locate and secure optical devices as needed.

Disclaimers

STANDARD TEST CONDITIONS

Unless otherwise stated, array testing is performed at the nominal drive current.

MINOR PRODUCT CHANGE POLICY

The rigorous qualification testing on products offered by Bridgelux provides performance assurance. Slight cosmetic changes that do not affect form, fit, or function may occur as Bridgelux continues product optimization.

About Bridgelux: Bridging Light and Life™

At Bridgelux, we help companies, industries and people experience the power and possibility of light. Since 2002, we've designed LED solutions that are high performing, energy efficient, cost effective and easy to integrate. Our focus is on light's impact on human behavior, delivering products that create better environments, experiences and returns—both experiential and financial. And our patented technology drives new platforms for commercial and industrial luminaires.

For more information about the company, please visit

bridgelux.com

twitter.com/Bridgelux

facebook.com/Bridgelux

youtube.com/user/Bridgelux

linkedin.com/company/bridgelux-inc-_2

WeChat ID: BridgeluxInChina



46430 Fremont Blvd
Fremont, CA 94538 USA
Tel (925) 583-8400
www.bridgelux.com

© 2020 Bridgelux, Inc. All rights reserved 2020. Product specifications are subject to change without notice. Bridgelux, the Bridgelux stylized logo design and Vesta are registered trademarks of Bridgelux, Inc. All other trademarks are the property of their respective owners.

Bridgelux Vesta Series Dim-To-Warm 15mm Array Product Data Sheet DS159 Rev. A (02/2020)