

CliQ DIN Rail Power Supply

12V 60W 1 Phase / DRP012V060W1AA



Highlights & Features

- Universal AC input voltage
- Power will not de-rate for the entire input voltage range
- Power Boost of 150% for 3 seconds
- Full corrosion resistant aluminium chassis
- Hazardous Locations approval to ATEX and Class I, Div 2
- Overvoltage / Overcurrent / Over Temperature / Short Circuit Protections

Safety Standards



CB Certified for worldwide use

Model Number: DRP012V060W1AA
Unit Weight: 0.33 kg (0.73 lb)
Dimensions (L x W x D): 121 x 32 x 120 mm
 (4.76 x 1.26 x 4.72 inch)

General Description

The DRP012V060W1AA is part of the CliQ DIN rail power supply series from one of the world's leading power supply companies, Delta Electronics Group. The rugged metal case has a compact body at only 32mm, which is both shock and vibration resistant according to IEC 60068-2 standard. The product operates within a wide temperature range from -20°C to +80°C. The DRP012V060W1AA features universal AC input voltage range from 85Vac to 264Vac and the power will not de-rate for the entire input voltage range. The single phase power supply unit includes overvoltage, overcurrent, over temperature and short circuit protections. The product features built-in Power Boost of 150% for 3 seconds. Such feature enables reserve power to be always available for reliable startup of loads with high inrush current, thus eliminating the need of a more expensive power supply unit at higher power rating. Another great feature is the conformal coating on the PCBA which allows DRP012V060W1AA to be certified to ATEX and Class I, Div 2 for use in hazardous locations.

Model Information

CliQ DIN Rail Power Supply

Model Number	Input Voltage Range	Rated Output Voltage	Rated Output Current
DRP012V060W1AA	85-264Vac (120-375Vdc)	12Vdc	5.00A

Model Numbering

DR	P	012V	060W	1	A	A
DIN Rail	Power Supply	Output Voltage	Output Power	Single Phase	CliQ Series	Metal Case

1 | All parameters are specified at 25°C ambient and AC input unless otherwise indicated. (November 2018, Rev. 06)



CliQ DIN Rail Power Supply

12V 60W 1 Phase / DRP012V060W1AA

Specifications

Input Ratings / Characteristics

Nominal Input Voltage	100-240Vac
Input Voltage Range	85-264Vac
Nominal Input Frequency	50-60Hz
Input Frequency Range	47-63Hz
DC Input Voltage Range*	120-375Vdc
Input Current	< 1.35A @ 115Vac, < 0.80A @ 230Vac
Efficiency at 100% Load	> 86.0% @ 115Vac & 230Vac
Max Inrush Current (Cold Start)	< 50A @ 115Vac, < 100A @ 230Vac
Leakage Current	< 1mA @ 240Vac

*Safety approval according to IEC/EN/UL 60950-1.

Output Ratings / Characteristics

Nominal Output Voltage	12Vdc
Output Voltage Tolerance	± 2% (initial set point tolerance from factory)
Output Voltage Adjustment Range	11-14Vdc
Output Current	5.00A (continuously operating at 12V) 7.50A (Power Boost for 3 seconds at 12V, refer to the details in the Functions section)
Output Power	60W (continuously operating at 12V) 90W (Power Boost for 3 seconds at 12V, refer to the details in the Functions section)
Line Regulation	< 0.5% typ. (@ 85-264Vac input, 100% load)
Load Regulation	< 1% typ. (@ 85-264Vac input, 0-100% load)
PARD (20MHz)	< 100mVpp
Rise Time	< 20ms @ nominal input (100% load)
Start-up Time	< 2,500ms @ nominal input (100% load)
Hold-up Time	> 22ms @ 115Vac, > 110ms @ 230Vac (100% load)
Dynamic Response (Overshoot & Undershoot O/P Voltage)	± 5% @ 0-100% load
Start-up with Capacitive Loads	8,000µF Max

CliQ DIN Rail Power Supply

12V 60W 1 Phase / DRP012V060W1AA

Mechanical

Case Cover / Chassis	Aluminium	
Dimensions (L x W x D)	121 x 32 x 120 mm (4.76 x 1.26 x 4.72 inch)	
Unit Weight	0.33 kg (0.73 lb)	
Indicator	Green LED (DC OK)	
Cooling System	Convection	
Terminal	Input	3 Pins (Rated 300V/20A)
	Output	2 Pins (Rated 300V/20A)
Wire	Input / Output	AWG 22-14
Mounting Rail	Standard TS35 DIN Rail in accordance with EN 60715	
Noise (1 Meter from power supply)	Sound Pressure Level (SPL) < 40dBA	

Environment

Surrounding Air Temperature	Operating	-20°C to +80°C
	Storage	-25°C to +85°C
Power De-rating	Vertical Mounting	> 50°C de-rate power by 2.5% / °C,
	Horizontal Mounting	> 70°C de-rate power by 4% / °C
Operating Humidity	5 to 95% RH (Non-Condensing)	
Operating Altitude	0 to 2,000 Meters (6,560 ft) (@ 50°C)	
Shock Test (Non-Operating)	IEC 60068-2-27, 30G (300m/S ²) for a duration of 18ms, 1 time per direction, 2 times in total	
Vibration (Non-Operating)	IEC 60068-2-6, 10Hz to 500Hz @ 50m/S ² (5G peak); 90 min per axis for all X, Y, Z direction	
Pollution Degree	2	

Protections

Overvoltage	16V, +10% / -5%, SELV Output, Hiccup Mode, Non-Latching (Auto-Recovery)
Overload / Overcurrent	> 150% of rated load current, Hiccup Mode, Non-Latching (Auto-Recovery)
Over Temperature	< 80°C Surrounding Air Temperature @ 100% load, Non-Latching (Auto-Recovery)
Short Circuit	Hiccup Mode, Non-Latching (Auto-Recovery when the fault is removed)
Protection Against Shock	Class I with PE* connection

*PE: Primary Earth

Reliability Data

MTBF	> 500,000 hrs. as per Telcordia SR-332 I/P: 115Vac, O/P: 100% load, Ta: 25°C
Expected Cap Life Time	10 years (115Vac & 230Vac, 50% load @ 40°C)

CliQ DIN Rail Power Supply

12V 60W 1 Phase / DRP012V060W1AA

Safety Standards / Directives

Electrical Equipment in Power Installations	EN 50178 / IEC 62103	
Electrical Safety	TUV to EN 60950-1, UL/cUL recognized to UL 60950-1 and CSA C22.2 No. 60950-1 (File No. E191395), CB scheme to IEC 60950-1	
Industrial Control Equipment	UL/cUL listed to UL 508 and CSA C22.2 No. 107.1-01 (File No. E315355), CSA to CSA C22.2 No. 107.1-01 (File No. 181564)	
Hazardous Location / ATEX	cCSAus to CSA C22.2 No. 213-M1987, ANSI / ISA 12.12.01:2011 Class I, Division 2, Group A, B, C, D T4, Ta= -20°C to +80°C (> +50°C derating)	
Ⓔ II 3G ATEX 94/9/EC	EN 60079-0:2012, EN 60079-15:2010 (Ⓔ II 3G Ex nA IIC T4 Gc, Ta= -20°C to +80°C (> +50°C derating)) Certificate No. EPS 12 ATEX 1 491 X	
CE	In conformance with EMC Directive 2014/30/EU and Low Voltage Directive 2014/35/EU In conformance with Equipment for explosive atmospheres (ATEX) directive 2014/34/EU	
Material and Parts	RoHS Directive 2011/65/EU Compliant	
Galvanic Isolation	Input to Output	4.0KVac
	Input to Ground	1.5KVac
	Output to Ground	1.5KVac

CliQ DIN Rail Power Supply

12V 60W 1 Phase / DRP012V060W1AA

EMC

EMC / Emissions		CISPR 32, EN 55032, CISPR 11, EN 55011, FCC Title 47: Class B
Immunity to		EN 55024, EN 61000-6-1, EN 61000-6-2
Electrostatic Discharge	IEC 61000-4-2	Level 4 Criteria A ¹⁾ Air Discharge: 15kV Contact Discharge: 8kV
Radiated Field	IEC 61000-4-3	Level 3 Criteria A ¹⁾ 80MHz-1GHz, 10V/M, 80% modulation (1kHz) 1.4GHz-2GHz, 3V/M, 80% modulation (1kHz) 2GHz-2.7GHz, 1V/M, 80% modulation (1kHz)
Electrical Fast Transient / Burst	IEC 61000-4-4	Level 3 Criteria A ¹⁾ 2kV
Surge	IEC 61000-4-5	Level 3 Criteria A ¹⁾ Common Mode ²⁾ : 2kV Differential Mode ³⁾ : 1kV
Conducted	IEC 61000-4-6	Level 3 Criteria A ¹⁾ 150kHz-80MHz, 10Vrms
Power Frequency Magnetic Fields	IEC 61000-4-8	Criteria A ¹⁾ 30A/Meter
Voltage Dips	IEC 61000-4-11	100% dip; 1 cycle (20ms); Self Recoverable
Low Energy Pulse Test (Ring Wave)	IEC 61000-4-12	Level 3 Criteria A ¹⁾ Common Mode ²⁾ : 2kV Differential Mode ³⁾ : 1kV
Voltage Fluctuation and Flicker		IEC/EN 61000-3-3

1) Criteria A: Normal performance within the specification limits

2) Asymmetrical: Common mode (Line to earth)

3) Symmetrical: Differential mode (Line to line)

CliQ DIN Rail Power Supply

12V 60W 1 Phase / DRP012V060W1AA

Block Diagram

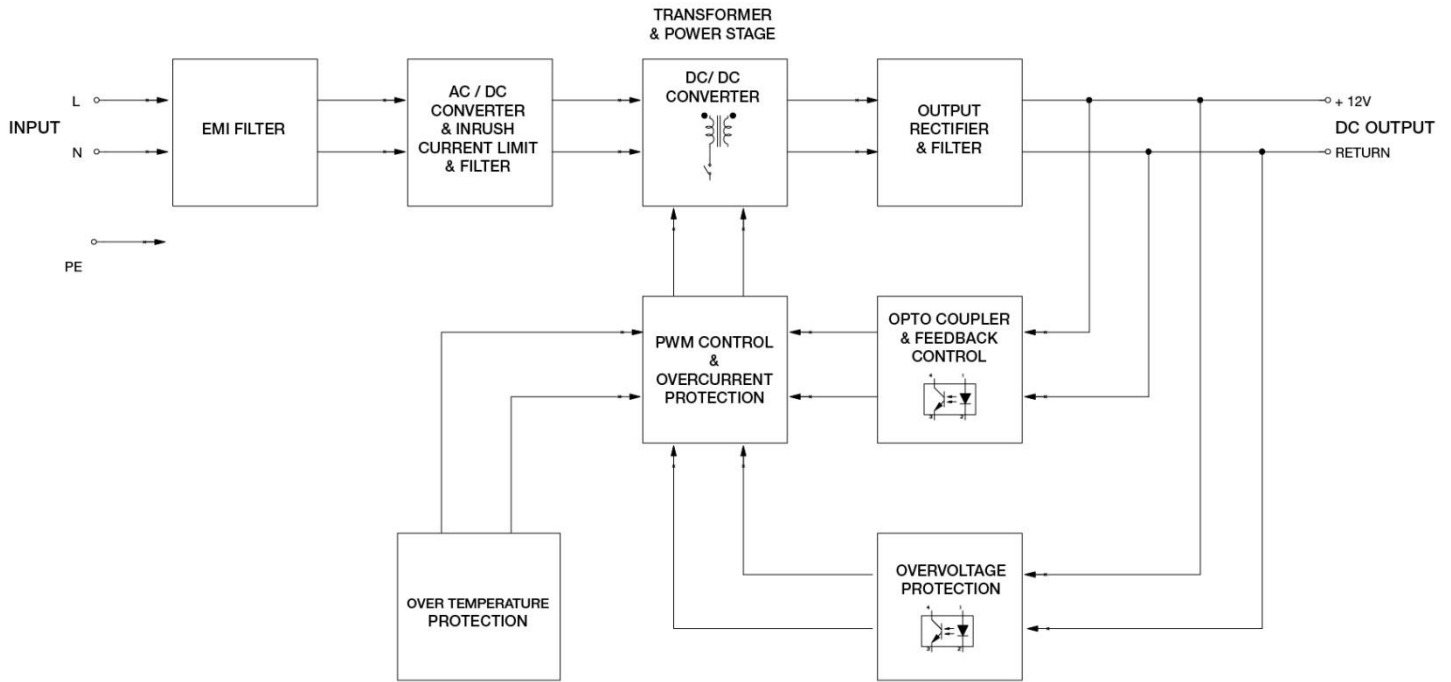

Device Description

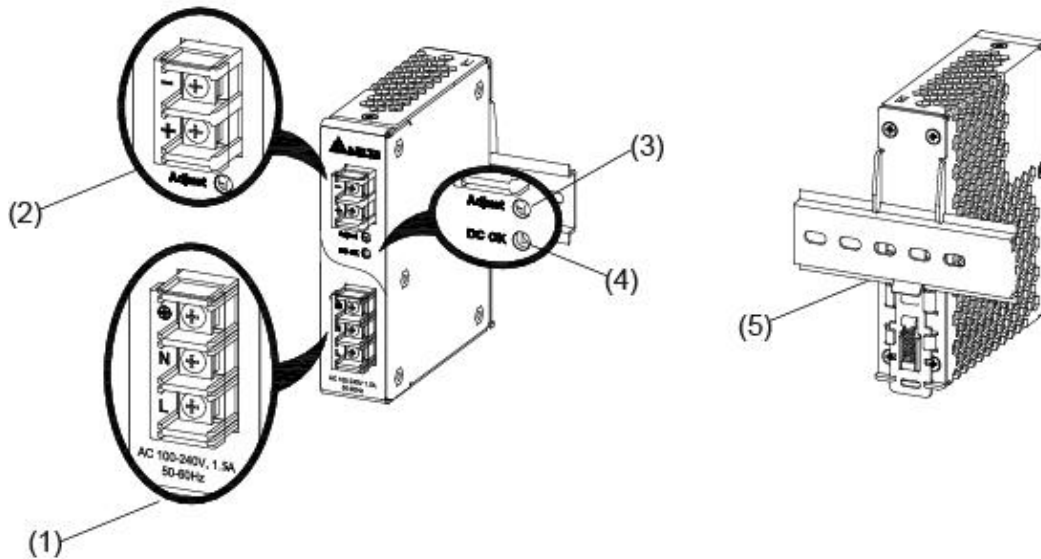

- 1) Input terminal block connector
- 2) Output terminal block connector
- 3) DC Voltage adjustment potentiometer
- 4) DC OK control LED (Green)
- 5) Universal mounting rail system

CliQ DIN Rail Power Supply

12V 60W 1 Phase / DRP012V060W1AA

Dimensions

L x W x D: 121 x 32 x 120 mm (4.76 x 1.26 x 4.72 inch)

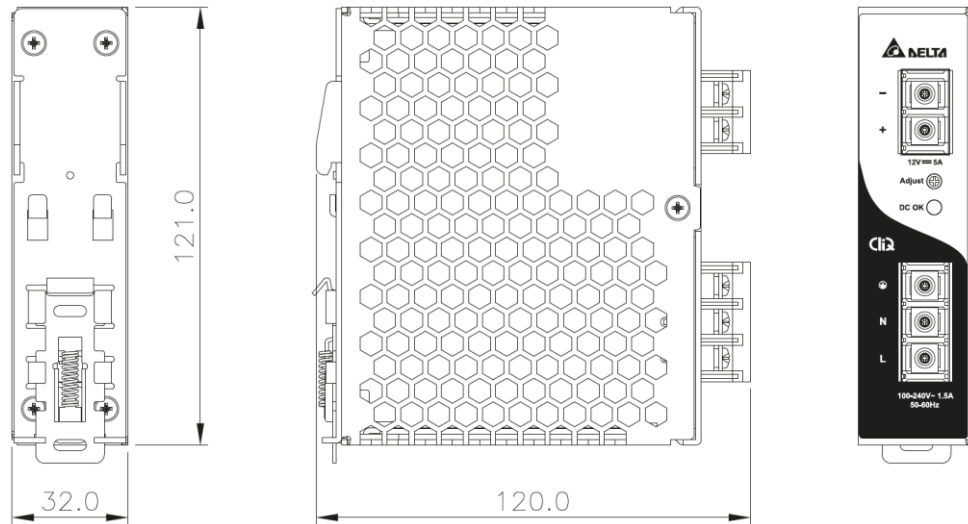

Engineering Data

Output Load De-rating VS Surrounding Air

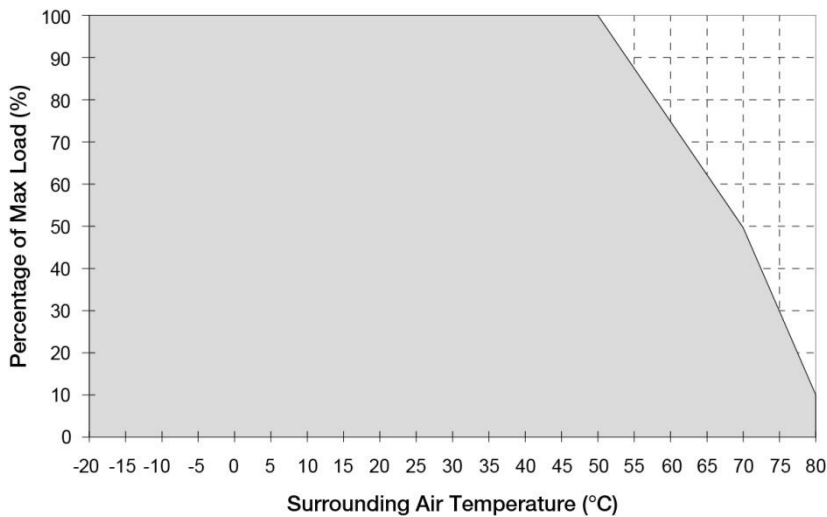

Fig. 1 De-rating for Vertical and Horizontal Mounting Orientation

> 50°C de-rate power by 2.5% / °C,
 > 70°C de-rate power by 4% / °C

Note

1. Power supply components may degrade, or be damaged, when the power supply is continuously used outside the shaded region, refer to the graph shown in Fig. 1.
2. If the output capacity is not reduced when the surrounding air temperature > 50°C, the device may run into Over Temperature Protection. When activated, the output voltage will go into bouncing mode and will recover when the surrounding air temperature is lowered or the load is reduced as far as necessary to keep the device in working condition.
3. In order for the device to function in the manner intended, it is also necessary to keep a safety distance of 20mm (for Vertical Mounting) or 50mm (for Horizontal Mounting) with adjacent units while the device is in operation.
4. Depending on the surrounding air temperature and output load delivered by the power supply, the device can be very hot!
5. If the device has to be mounted in any other orientation, please do not hesitate to contact info@deltapsu.com for more details.

CliQ DIN Rail Power Supply

12V 60W 1 Phase / DRP012V060W1AA

Output Load De-rating VS. Input Voltage

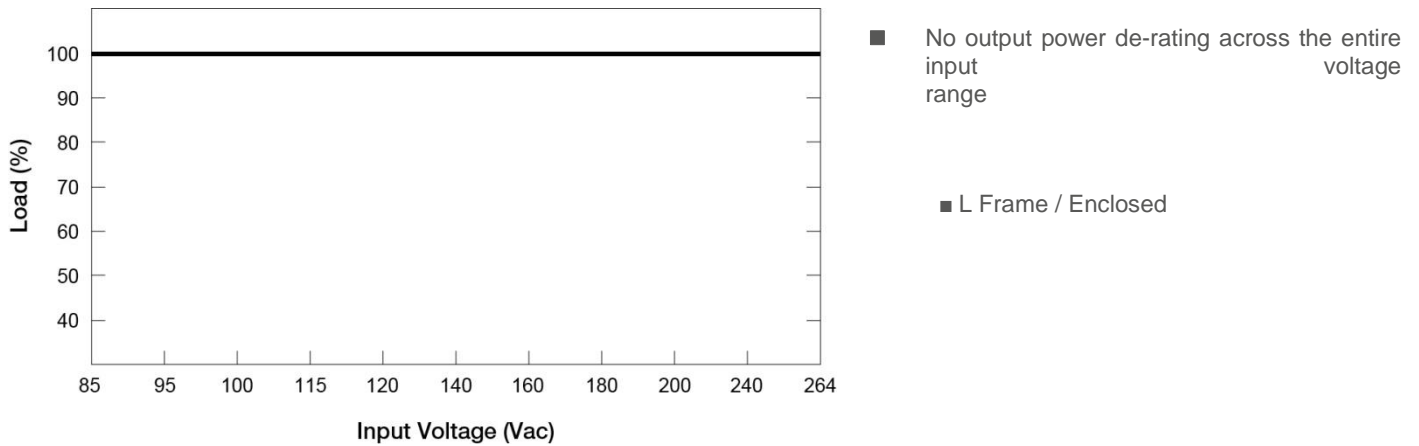

Assembly & Installation

The power supply unit (PSU) can be mounted on 35mm DIN rails in accordance with EN 60715. The device should be installed with input terminal block at the bottom.

Each device is delivered ready to install.

Mounting

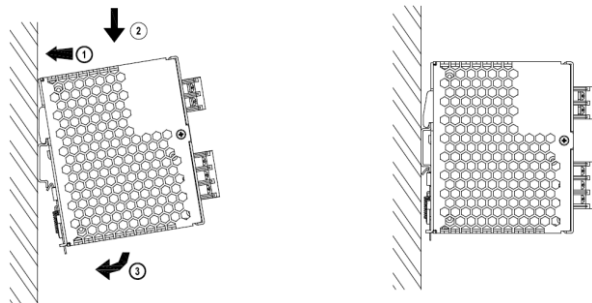

Fig. 2.1 Mounting

Snap on the DIN rail as shown in Fig. 2.1:

1. Tilt the unit upwards and insert it onto the DIN rail.
2. Push downwards until stopped.
3. Press against the bottom front side for locking.
4. Shake the unit slightly to ensure that it is secured.

Dismounting

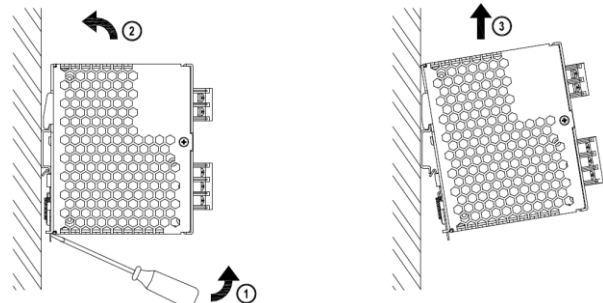

Fig. 2.2 Dismounting

To uninstall, pull or slide down the latch with screw driver as shown in Fig. 2.2. Then slide the power supply unit (PSU) in the opposite direction, release the latch and pull out the power supply unit (PSU) from the rail.

In accordance to EN 60950 / UL 50950, flexible cables require ferrules.

Use appropriate copper cables designed to sustain operating temperature of at least 75°C or more to fulfill UL requirements.

For stranded wires it is recommended to use suitable lug to crimp wires.

CliQ DIN Rail Power Supply

12V 60W 1 Phase / DRP012V060W1AA

Safety Instructions

■ Vertical Mounting

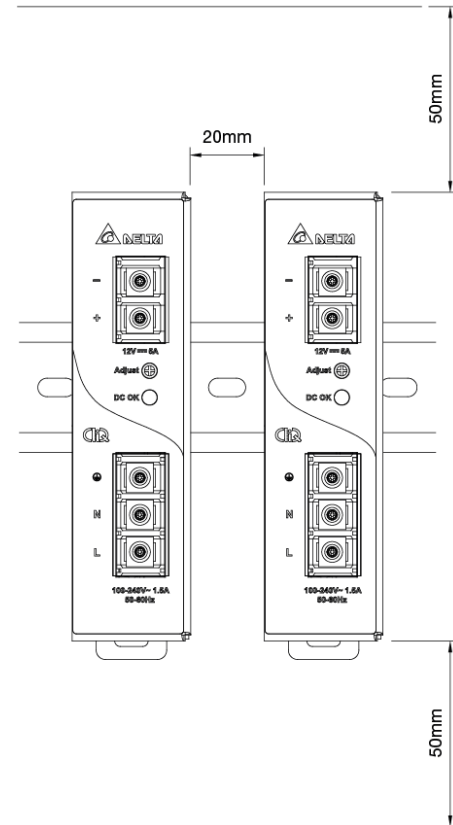

■ Horizontal Mounting

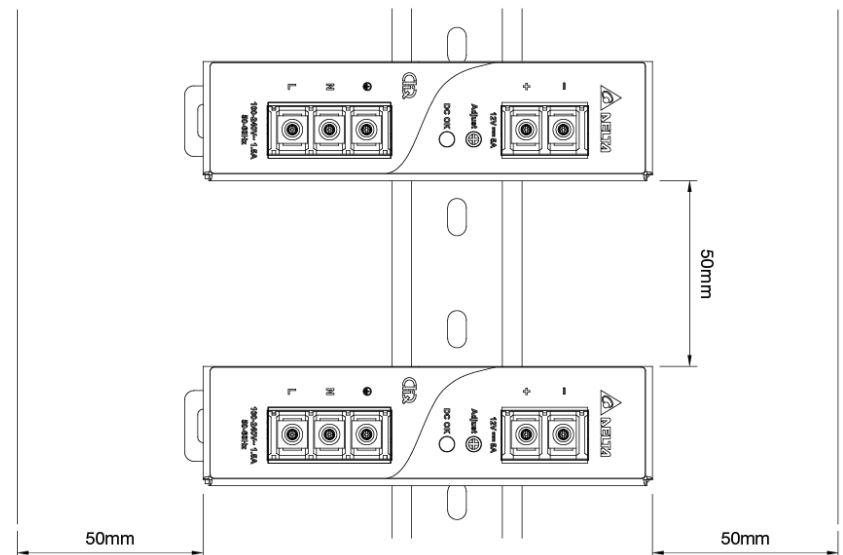

- ALWAYS switch mains of input power OFF before connecting and disconnecting the input voltage to the unit. If mains are not turned OFF, there is risk of explosion / severe damage.
- **To guarantee sufficient convection cooling, keep a distance of 50mm above and below the device as well as a lateral distance of 20mm (for Vertical Mounting) or 50mm (for Horizontal Mounting) to other units.**
- Note that the enclosure of the device can become very hot depending on the surrounding air temperature and load of the power supply. Risk of burns!
- Only plug in and unplug connectors when power is turned off!
- DO NOT insert any objects into the unit.
- Hazardous voltages may be present for up to 5 minutes after the input mains voltage is disconnected. Do not touch the unit during this time.
- The power supplies are built in units and must be installed in a cabinet or room (condensation free environment and indoor location) that is relatively free of conductive contaminants.
- CAUTION: "For use in a controlled environment".
- The power supplies unit must be installed in an IP54 enclosure or cabinet in the final installation. The enclosure or cabinet must comply with EN 60079-0 or EN 60079-15.
- Warning: Explosion Hazard - Substitution of components may impair suitability for Class I, Division 2.
- Warning: Explosion Hazard - Do not disconnect equipment or adjust potentiometer unless the power has been switched off or the area is known to be non-hazardous.

CliQ DIN Rail Power Supply

12V 60W 1 Phase / DRP012V060W1AA

Functions

■ Graph illustrating the Start-up Time, Rise Time, and Hold-up Time

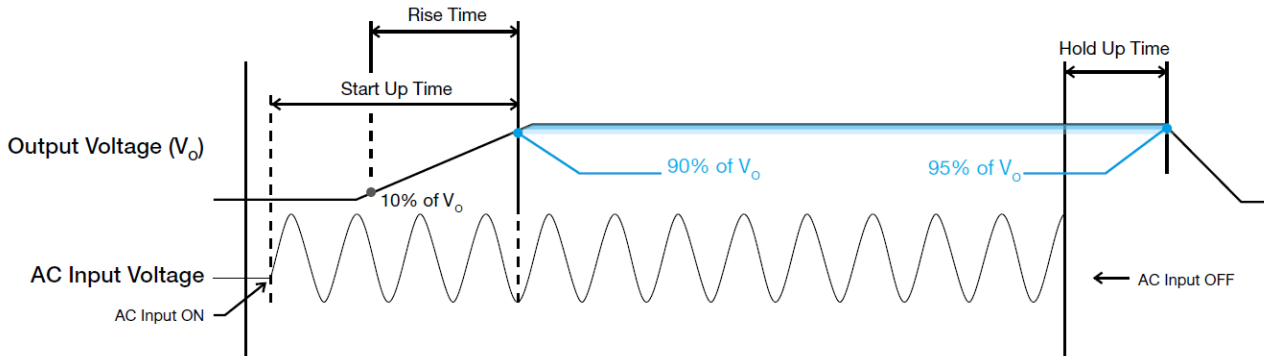

Start-up Time

The time required for the output voltage to reach 90% of its set value, after the input voltage is applied.

Rise Time

The time required for the output voltage to change from 10% to 90% of its set value.

Hold-up Time

Hold up time is the time when the AC input collapses and output voltage retains regulation for a certain period of time. The time required for the output to reach 90% of its set value, after the input voltage is removed.

Inrush Current

Inrush current is the peak, instantaneous, input current measured and, occurs when the input voltage is first applied. For AC input voltages, the maximum peak value of inrush current will occur during the first half cycle of the applied AC voltage. This peak value decreases exponentially during subsequent cycles of AC voltage.

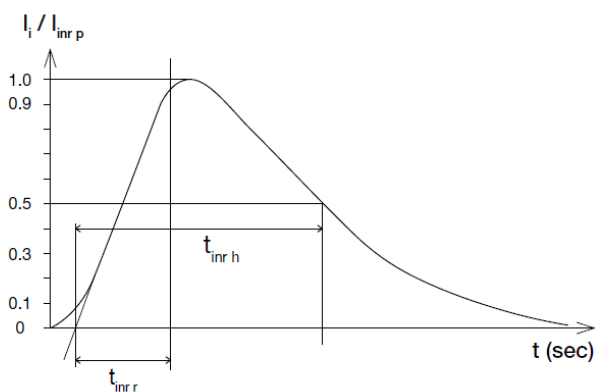

Dynamic Response

The power supply output voltage will remain within $\pm 5\%$ of its steady state value, when subjected to a dynamic load from 0 to 100% of its rated current.

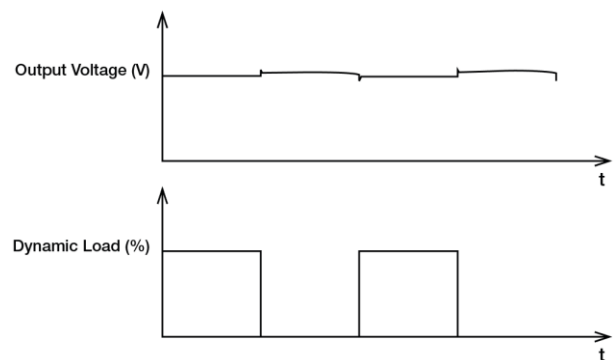

CliQ DIN Rail Power Supply

12V 60W 1 Phase / DRP012V060W1AA

Power Boost

Power Boost is the reserve power available constantly that allows reliable startup to support sudden and short spike of loads with high inrush current typically during turn on to remove the need of more expensive higher rated power supply unit. After the output has reached its steady state set value, the power supply can support surge loads with a higher short-term power demand up to 150% of maximum rated load (I_o Max), for a maximum duration of 3 seconds. The Power Boost is also available to repeatedly basis with according to the condition of an average (R.M.S) output power shall not exceed continuous operating condition or refer to duty cycle calculation below.

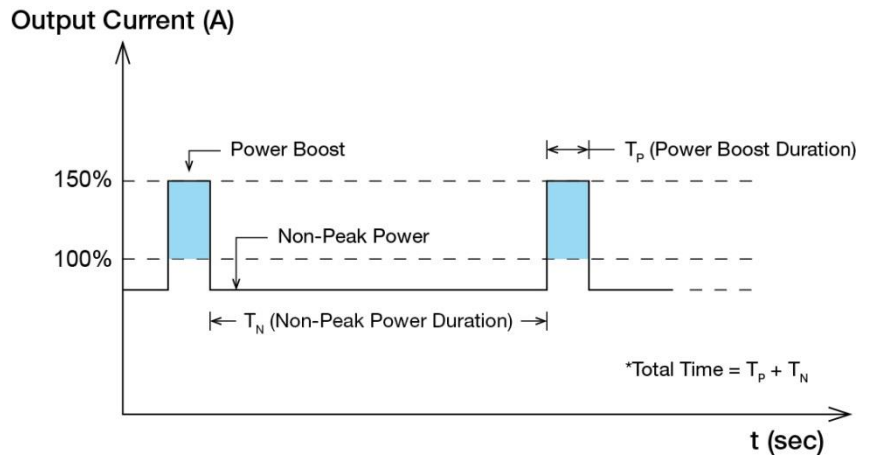

$$Duty\ cycle\ (\%) = \frac{T_p}{Total\ Time}$$

$$Average\ Output\ Power\ (P_{Avg}) = \frac{(Power\ Boost \times T_p) + (Non-Peak\ Power \times T_n)}{Total\ Time}$$

OR

$$Non-Peak\ Power = \frac{(P_{Avg} \times Total\ Time) - (Power\ Boost \times T_p)}{T_n}$$

■ An example of Power Boost and Average Output Power

Power Boost	Peak Power (W _P)	Power Boost Duration (T _P)	Duty Cycle	Non-Peak Power (W _N)	Non-Peak Power Duration (T _N)	Total Time (T)
150%	90	3 sec	10%	57W	27 sec	30 sec
150%	90	3 sec	35%	44W	5.5 sec	8.5 sec
120%	72	6 sec	20%	57W	24 sec	30 sec
120%	72	6 sec	35%	53W	11 sec	17 sec

It is not recommended to prolong the duration of Power Boost to be longer than the specified duty cycle calculation, this may cause damage to the PSU.

CliQ DIN Rail Power Supply

12V 60W 1 Phase / DRP012V060W1AA

Overload & Overcurrent Protections

The power supply's Overload (OLP) and Overcurrent (OCP) Protections will be activated when output current exceeds 150% of I_O (Max load). In such occurrence, the V_O will start to droop and once the power supply has reached its maximum power limit, the protection is activated and the power supply will go into "Hiccup mode" (Auto-Recovery). The power supply will recover once the fault condition of the OLP and OCP is removed and I_O is back within the specifications.

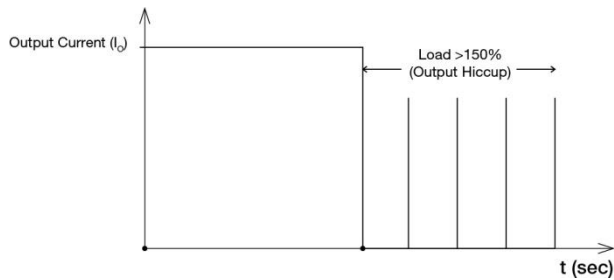

It is not recommended to prolong the duration of I_o when it is <150% but >100%, since it may cause damage to the PSU.

Short Circuit Protection

The power supply's output OLP/OCP function also provides protection against short circuits. When a short circuit is applied, the output current will operate in "Hiccup mode", as shown in the illustration in the OLP/OCP section on this page. The power supply will return to normal operation after the short circuit is removed.

Overvoltage Protection

The power supply's overvoltage circuit will be activated when its internal feedback circuit fails. The output voltage shall not exceed its specifications defined on Page 3 under "Protections". The power supply doesn't shut down but goes in 2nd level regulation at 15-16Vdc and continue to deliver the power. According to high output voltage which will be operating > 100% of rated load (16V x rated output current), if this condition persists, the power supply will sense OTP (Over Temperature Protection) and will go under hiccup mode. The power will return to normal operation once the fault condition is removed.

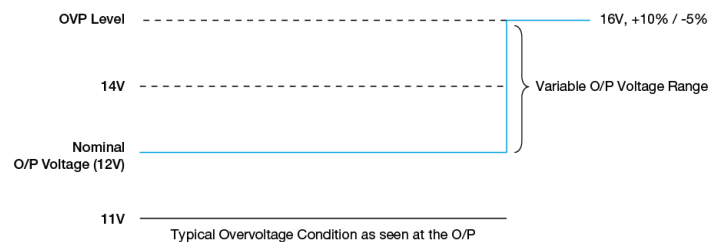

Over Temperature Protection

As mentioned above, the power supply also has Over Temperature Protection (OTP). In the event of a higher operating temperature at 100% load, the power supply will run into OTP when the operating temperature is beyond what is recommended in the de-rating graph. When activated, the output voltage will go into bouncing mode until the temperature drops to its normal operating temperature as recommended in the de-rating graph.

CliQ DIN Rail Power Supply

12V 60W 1 Phase / DRP012V060W1AA

Others

Delta RoHS Compliant



Restriction of the usage of hazardous substances

The European directive 2011/65/EU limits the maximum impurity level of homogeneous materials such as lead, mercury, cadmium, chrome, polybrominated flame retardants PBB and PBDE for the use in electrical and electronic equipment. RoHS is the abbreviation for "Restriction of the use of certain hazardous substances in electrical and electronic equipment".

This product conforms to this standard.

Conformal Coating

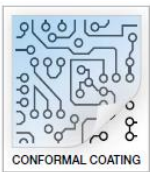

The Protective Coating Technology

Delta Electronics Group has designed the perfect dipping technique which penetrates everywhere including under device, and prevents leakage. The conformal coating dipping can be applied to PCBAs or circuit board. The coating preserves the performance of precision electronic primarily by preventing ionizable contaminants such as salt from reaching circuit nodes, where the material slumps around sharp edges. This can be a problem especially in highly conversing atmosphere.

Attention

Delta provides all information in the datasheets on an "AS IS" basis and does not offer any kind of warranty through the information for using the product. In the event of any discrepancy between the information in the catalog and datasheets, the datasheets shall prevail (please refer to www.DeltaPSU.com for the latest datasheets information). Delta shall have no liability of indemnification for any claim or action arising from any error for the provided information in the datasheets. Customer shall take its responsibility for evaluation of using the product before placing an order with Delta.

Delta reserves the right to make changes to the information described in the datasheets without notice.