

# Medical / Industrial AC-DC Power Supply

## MEP-200A Series / 200 W, Convection Cooling and Low Profile

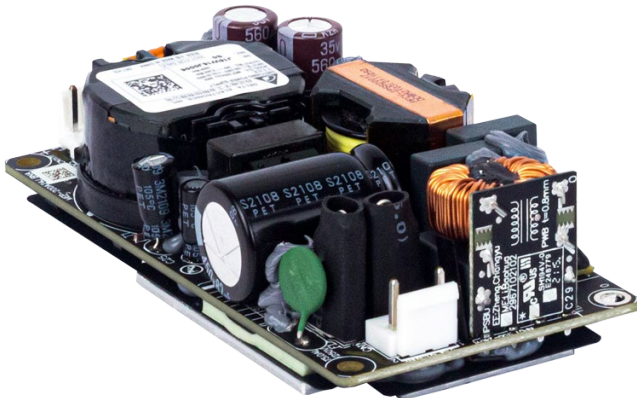

### Highlights & Features

- 2" x 4" x 1.12" low profile
- Up to 22.32 W/inch<sup>3</sup> power density
- Up to 200 W output with natural convection cooling
- Up to 70 °C ambient operation
- High efficiency up to 95%
- Up to 1,000 KHrs MTBF
- 2 x MOPP isolation
- Suitable for type BF medical products
- Conformal coating (optional)
- Class B conducted and radiated EMI
- IEC 60601-1-2 (4<sup>th</sup> Edition) immunity compliance
- Applicable to Class I/II system

### Safety Certifications

- IEC60601-1 2<sup>nd</sup> edition
- IEC60601-1 3<sup>rd</sup> edition + A1 CB report
- TUV EN60601-1:2006/A11/A12
- UL60601-1+CAN/CSA 60601-1: (Ed.3.2005)
- IEC60950-1 CB report
- IEC62368-1 CB report
- UL 62368-1 and CAN/CSA C22.2 No. 62368-1
- IEC60335-1 CB report
- IEC61558-1 &-2-16 CB report

Input			
Input Voltage	90 Vac ~ 264 Vac		
Input Frequency	47 Hz ~ 63 Hz		
Input Current	< 2.5 A		
Inrush Current	< 60 A cold start		
Power Factor	> 0.95 at rated load		
Efficiency	Up to 95% <sup>1)</sup>		
Patient Leakage Current	< 100 uA normal, < 500 uA SFC		
Earth Leakage Current	< 300 uA normal, < 1 mA SFC		
Output			
Output Voltage	12 V	24 V	48 V
Output Current	0 - 16.67 A	0 - 8.34 A	0 - 4.17 A
Ripple & Noise	< 1 % Vrated pk-pk		
Operating Environment			
MTBF	1,000 KHrs		
Operation Temperature	-30 °C ~ 70 °C <sup>1)</sup>		
Operation Altitude	5,000 m or 54 kPa		

1) Power de-rating with temperature above 45°C, refer to power de-rating curve for detail

# Medical / Industrial AC-DC Power Supply

## MEP-200A Series / 200 W, Convection Cooling and Low Profile

### Model Information

Model Name	Input Voltage	Output Voltage	Current Output
MEP-200A12J BNA	90 - 264 Vac	12 Vdc	0-16.67 A
MEP-200A24J BNA	90 - 264 Vac	24 Vdc	0-8.34 A
MEP-200A48J BNA (planning)	90 - 264 Vac	48 Vdc	0-4.17 A

### Model Name

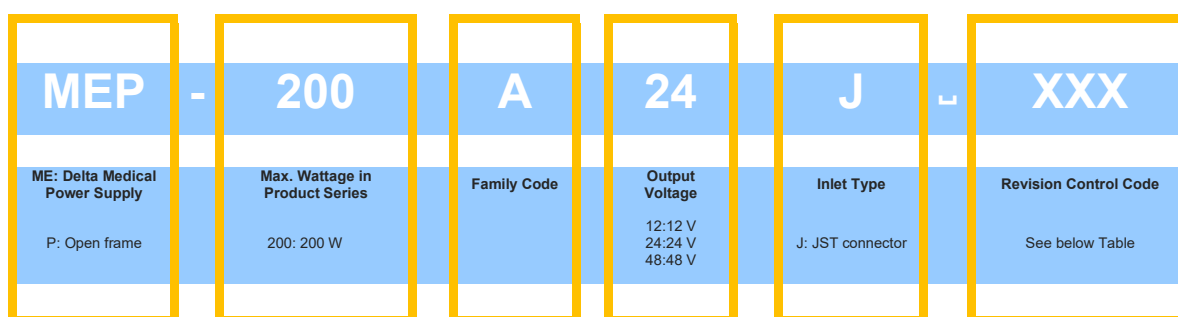

### Revision Control Code

Revision Control Code	Package
BNA	Delta standard, no conformal coating, with base

# Medical / Industrial AC-DC Power Supply

## MEP-200A Series / 200 W, Convection Cooling and Low Profile

### Specifications

#### Input Ratings / Characteristics

Nominal Input Voltage	100 - 240 Vac
Input Voltage Range	90 - 264 Vac
Nominal Input Frequency	50 - 60 Hz
Input Frequency Range	47 - 63 Hz
Input Current (max.)	2.5 A
Input Surge Voltage (max.)	300 Vac for 100 ms
Full load Efficiency	For 12 V output model 92.4 % at 115 Vac / 60 Hz, 93.8 % at 230 Vac / 50 Hz For 24 V output model 93.3 % at 115 Vac / 60 Hz, 94.7 % at 230 Vac / 50 Hz, For 48 V output Model 93.8 % @ 115 Vac / 60 Hz, 95.4% @ 230 Vac / 50 Hz,
Inrush Current (max.)	60 A at 264 Vac, cold start
Input-PE (protective earth) Leakage Current (max.)	0.3 mA at NC, 1mA at SFC 1)
Output-PE (protective earth) Leakage Current for Type BF Application (max.)	0.1 mA at NC, 0.5mA at SFC 1)
Power Factor (min.)	0.95 at 115 V & 230 Vac / 50 Hz, full load

1) NC: normal condition, SFC: single fault condition

#### Leakage Current

Input-PE Leakage Current	100 Vac / 60 Hz (Typ)	264 Vac / 60 Hz (Typ)	Delta Limit	IEC60601-1 Limit
Normal Condition	27 uA	71 uA	300 uA max	5,000 uA max
Single Fault Condition	59 uA	156 uA	1,000 uA max	10,000 uA max
Output-PE Leakage Current for Type BF Application				
Normal Condition	27 uA	71 uA	100 uA max	100 uA max
Single Fault Condition	60 uA	159 uA	500 uA max	500 uA max

# Medical / Industrial AC-DC Power Supply

## MEP-200A Series / 200 W, Convection Cooling and Low Profile

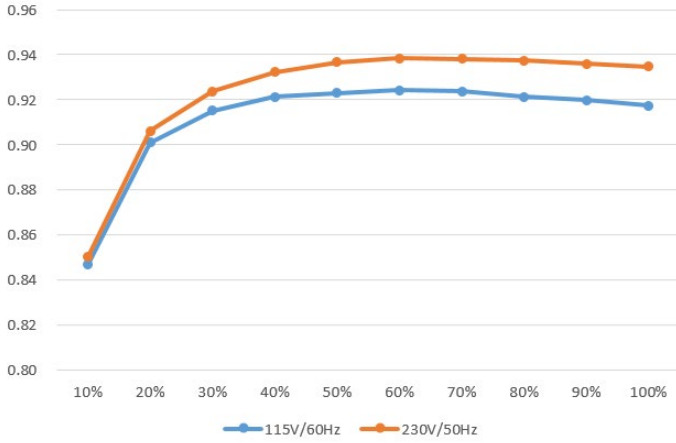

Figure 1. Typical Efficiency Curve for 12 V (max. 200 W)

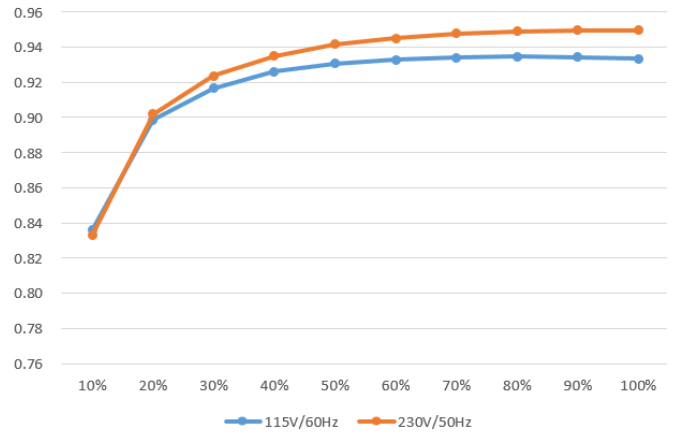

Figure 2. Typical Efficiency Curve for 24 V (max. 200 W)

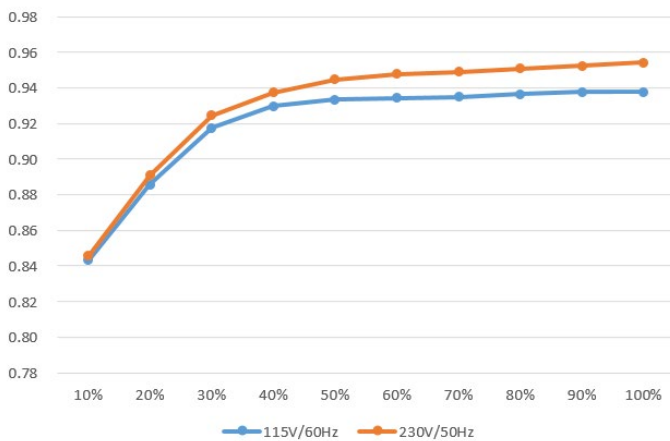

Figure 3. Typical Efficiency Curve for 48 V (max. 200 W)

# Medical / Industrial AC-DC Power Supply

## MEP-200A Series / 200 W, Convection Cooling and Low Profile

### Output Ratings / Characteristics

Total Regulation	± 3 %
Output Power (max.)	200 W
Line Regulation (max.)	1 %
Load Regulation (max.)	2 %
Ripple & Noise (typ.)	1 % pk-pk Vrated or 150 mV which is larger at rated load Reference: Figure. 4
Dynamic Response (overshoot & undershoot O/P voltage)	± 10 % at with 5 ~ 100 % load change
Start-up Time (max.)	1,000 ms with AC turn on
Hold-up Time (min.)	12 ms at 180 W load, with nominal input range
Capacitive Load (max.)	1,500 µF
Rise Time (max.)	< 50 ms



(a) 115 V (measured value = 187 mV)



(b) 230 V (measured value = 171 mV)

Figure.4 24V Output Model Ripple & Noise Example, 20 MHz BW

### Operating Environment

Surrounding Air Temperature	Operating	Absolute maximum/minimum rating -30 °C to +70 °C. Linear power derate from 100 % load at 45 °C to 50 % load at 70 °C with 2 %/°C (24 V / 48 V model) Linear power derate from 100 % load at 40 °C to 50 % load at 70 °C with 2 %/°C (12 V) Note: see power de-rating curves below
	Storage	-40 °C to +85 °C
Operating Humidity		5-95 % RH (Non-condensing)
Operating Altitude		Up to 5,000 meters (up to 16,400 feet or 106-54kPa)
Non-Operating Altitude		Up to 5,575 meters (up to 18,290 feet or 106-50kPa)
Shock Test (Non-Operating)		50 G, 11 ms, 3 shocks for each direction
Vibration (Non-Operating)		5 – 500 Hz, 2 Grms, 15 minute for each three axis



# Medical / Industrial AC-DC Power Supply

## MEP-200A Series / 200 W, Convection Cooling and Low Profile

### Mechanical

Package	Open frame
Dimensions (W x L x H)	50.8 x 101.6 x 28.5 mm 2 x 4 x 1.12 inch
Unit Weight	0.21 kg

### Power De-rating Curve (Convection)

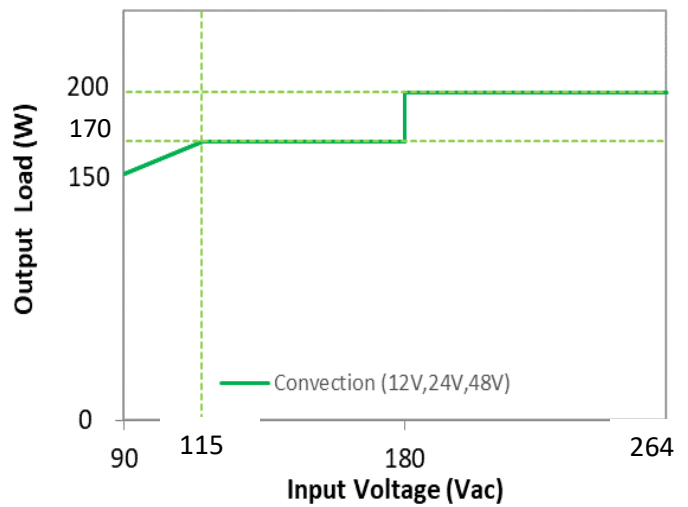
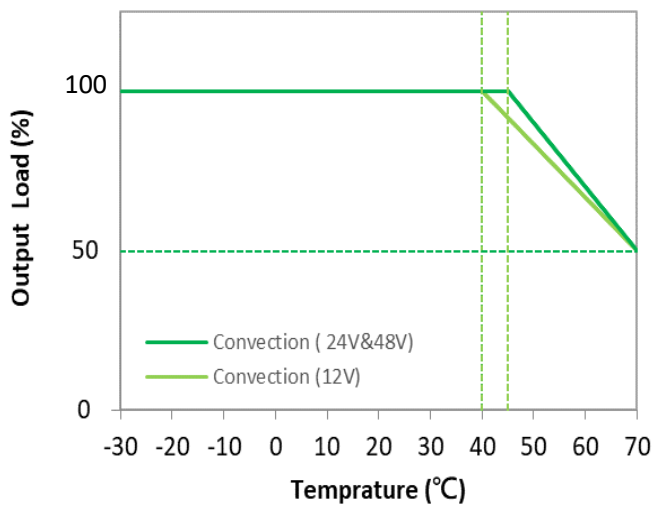

### Power De-rating Curve (Force Air)

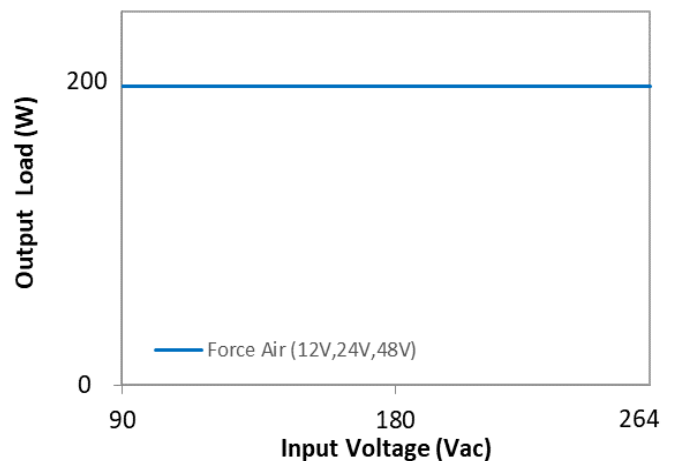
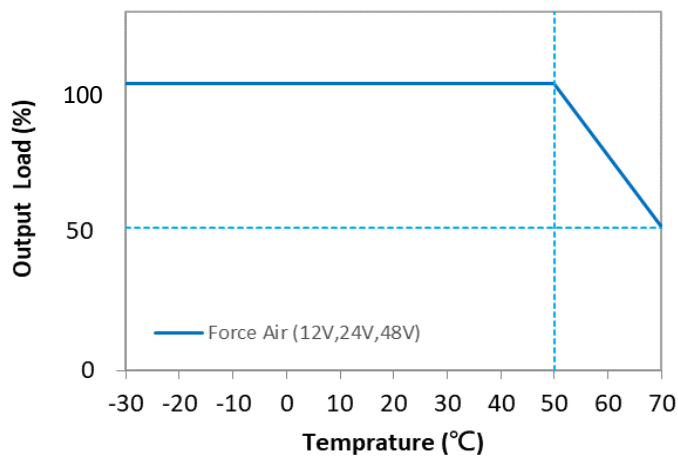

# Medical / Industrial AC-DC Power Supply

## MEP-200A Series / 200 W, Convection Cooling and Low Profile

### Load De-rating Fixture and Test Setup (FAN: EFB0412VHD).

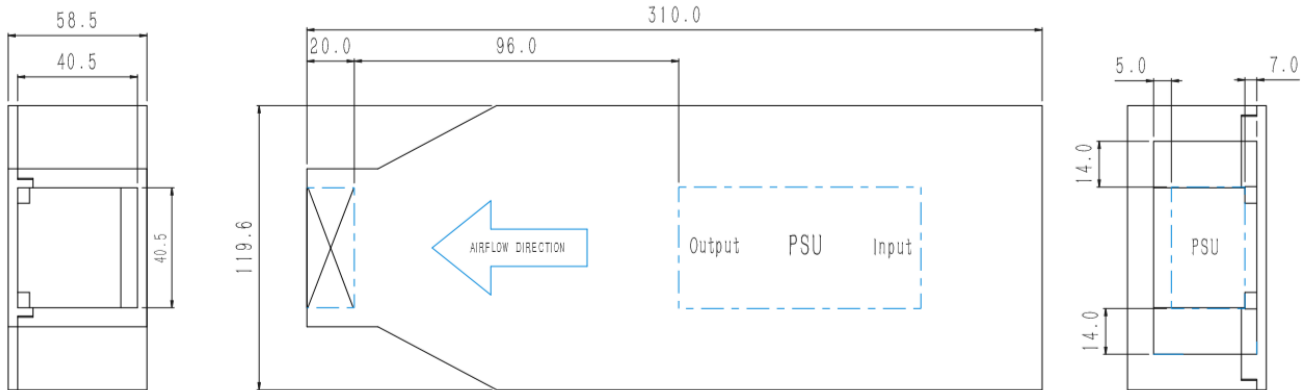

### Convection Test Setup

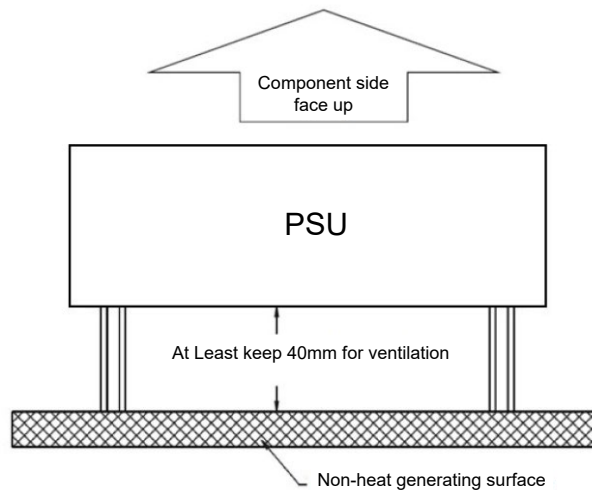

Notes 1 (For MEP-200A24J BNA/MEP-200A48J BNA):

1. Fan source and box dimensions could be changed or modified to meet air speed: 0.86 m/s
2. Airflow: 5.2 CFM (For reference, a ir speed should meet 0.86 m/s)
3. Used fan voltage: 7.0 V (For reference, the voltage should be adjusted for every fan to meet air speed: 0.86 m/s)
4. Unit: mm

Notes 2 (For MEP-200A12J BNA):

5. Fan source and box dimensions could be changed or modified to meet air speed: 0.99 m/s
6. Airflow: 6.0 CFM (For reference, air speed should meet 0.99 m/s)
7. Used fan voltage: 8.0 V (For reference, the voltage should be adjusted for every fan to meet air speed: 0.99 m/s)
8. Unit: mm

# Medical / Industrial AC-DC Power Supply

## MEP-200A Series / 200 W, Convection Cooling and Low Profile

### Protections

Overvoltage (max.)	Main output 125 % of rated normal voltage, latch mode
Over Load / Over Current (max.)	Main output 140 % of rated current (Non-latching, auto-recovery)
Over Temperature	Latch mode for main output
Short Circuit	Hiccup mode for main output (Non-latching, auto-recovery)

### Reliability Data

MTBF (Minimum) at 115 Vac, 170 W, 35 °C	1,000 Khrs based on Telecordia SR-332
Operating life(Minimum) at 115 Vac, 170 W, 25 °C	26,280 hrs

### Safety Standards / Directives

Medical Safety	IEC60601-1 2 <sup>nd</sup> and 3 <sup>rd</sup> +A1 edition CB report TUV EN60601-1 (2006) ANSI/AAMI ES 60601-1+CAN/CSA-C22.2 No.60601-1: (Ed.3.2005)
ITE Safety	IEC60950-1 CB report IEC62368-1 CB report TUV EN 62368-1 UL 62368-1 and CAN/CSA C22.2 No. 62368-1
Household (for MEP-200A12&24J BNA)	IEC60335-1 CB report IEC61558-1&-2-16 CB report TUV EN 60335-1 TUV EN 61558-1 & -2-16
CE	In conformance with EN 60601-1: 2006 + A11: 2011 + A1: 2013 + A12: 2014& EN 60601-1-2: 2015
UKCA	In conformance with Electromagnetic Compatibility Regulations 2016 and Medical Devices Regulations 2002 (UK MDR 2002)
Galvanic Isolation	Input to / Output (2 XMOPP) 4,000 Vac Input to / Ground (1 XMOPP) 1,500 Vac Output to / Ground (1 XMOPP) 1,500 Vac (Type BF application rated)



# Medical / Industrial AC-DC Power Supply

## MEP-200A Series / 200 W, Convection Cooling and Low Profile

### EMC

EMC / Emissions		EN 55011/EN 55032, FCC Title 47: Class B for Class I Note: Class B Radiated Emission for Class II connection without earth connection needs to add EMI filter. Please consult with Delta for detailed information.
Harmonic Current Emissions	IEC 61000-3-2	Meet Class D limit
Immunity to		
Voltage Flicker	IEC 61000-3-3	
Electrostatic Discharge	IEC 61000-4-2	Level 4 criteria A <sup>1)5)</sup> Air discharge: 15 kV Contact discharge: 8 kV
Radiated Field	IEC 61000-4-3	Criteria A <sup>1)</sup> 80 MHz – 2,700 MHz, 10 V/m AM modulation  Level 2 Criteria A <sup>1)5)</sup> 385 MHz – 5,785 MHz, 28 V/m pulse mode and other modulation
Electrical Fast Transient / Burst	IEC 61000-4-4	Level 3 Criteria A <sup>1)</sup> : 2 kV
Surge	IEC 61000-4-5	Level 3 Criteria A <sup>1)5)</sup> Common Mode <sup>3)</sup> : 2 kV Differential Mode <sup>4)</sup> : 1 kV
Conducted	IEC 61000-4-6	Level 2 Criteria A <sup>1)5)</sup> 150 kHz – 80 MHz, 3 Vrms, 6 Vrms at ISM bands and Amateur radio bands
Power Frequency Magnetic Fields	IEC 61000-4-8	Criteria A <sup>1)5)</sup> Magnetic field strength 30 A/m
Voltage Dips	IEC 61000-4-11	30 % 10 ms Criteria A <sup>1)</sup> 60 % 100 ms Criteria B <sup>2)</sup> 100 % 5,000 ms Criteria B <sup>2)</sup>
Voltage Dips <sup>5)</sup>	IEC 60601-1-2	Criteria A <sup>1)</sup> 0% U <sub>T</sub> , 0.5 cycle (10 ms) (0°, 45°, 90°, 135°, 180°, 225°, 270°, 315°, 360°) Criteria B <sup>2)</sup> , can meet Criteria A with 120 W or lower load 0% U <sub>T</sub> , 1 cycle (20 ms), 0° Criteria B <sup>2)</sup> 70% U <sub>T</sub> , 25 cycle (500 ms), 0° Criteria B <sup>2)</sup> 0% U <sub>T</sub> , 250 cycle (5,000 ms), 0°

1) Criteria A: Normal performance within the specification limits

2) Criteria B: Irregular output or shut down during test. Automatically restored to normal operation after test.

3) Asymmetrical: Common mode (Line to earth)

4) Symmetrical: Differential mode (Line to line)

5) Compliant with IEC60601-1-2 (4<sup>th</sup> Edition )

# Medical / Industrial AC-DC Power Supply

## MEP-200A Series / 200 W, Convection Cooling and Low Profile

### Dimensions and Mechanical Drawing (MEP-200)

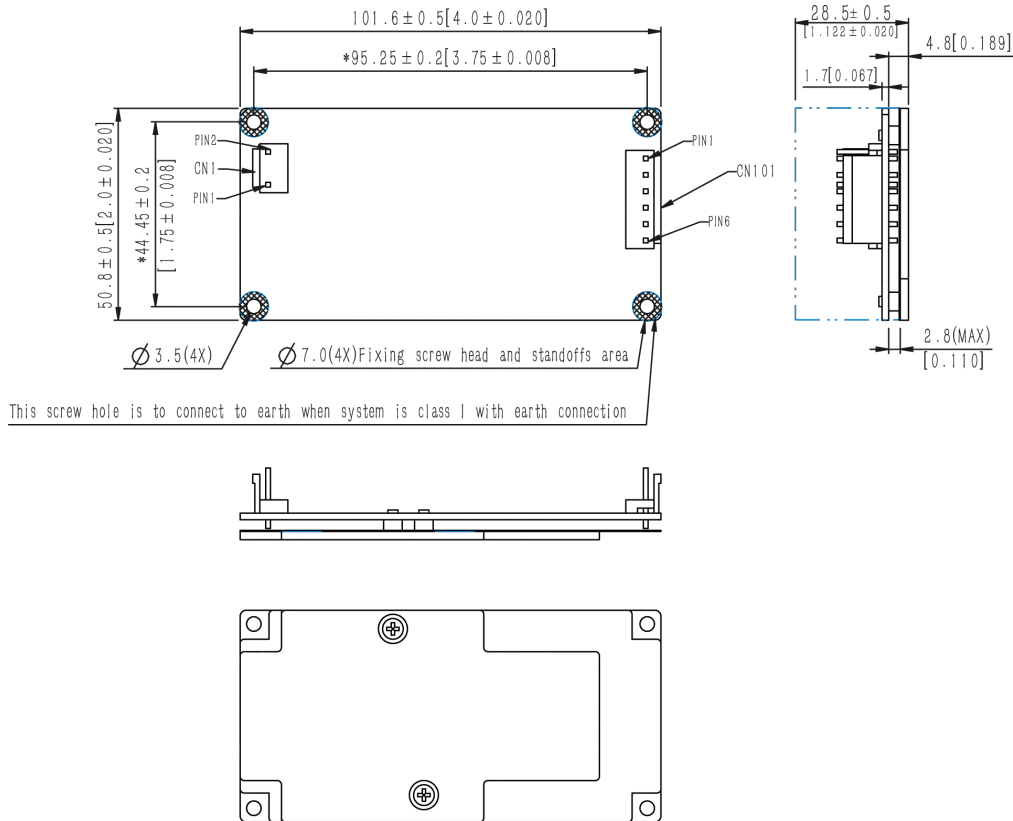

- Notes:**
- All dimensions are in millimeters and inches.
  - The base plate is not earth connected just for heating dissipation, but can be used for conduction cooling. Users need to consider safety isolation requirement when assembly the PSU. Please consult with Delta before installation.

### Connector Definition and Pin Assignment

Input Connector CN1	
Pin 1	Neutral
Pin 2	Line
CN1: JST(HEADER): B2P3-VH MATCH WITH JST(HOUSING): VAR-2 JST(CRIMP SOCKET): SVA-41T-P1.	
Output Connector CN101	
PIN1-3	Output +
PIN4-6	Output -
CN101: JST (HEADER): B6P-VH-B (LF) (SN) MATCH WITH JST(HOUSING): VHR-6N JST (CRIMP SOCKET): SVH-21T-P1.1	



# Medical / Industrial AC-DC Power Supply

## MEP-200A Series / 200 W, Convection Cooling and Low Profile

### Functions

#### Start-up Time

The time required for output voltage to reach 90% of its final steady state value, after the input voltage is applied.

#### Rise Time

The time required for output voltage to change from 10 % to 90 % of its final steady state value.

#### Hold-up Time

Time between the collapse of the AC input voltage, and the output falling to 90 % of its steady state value.

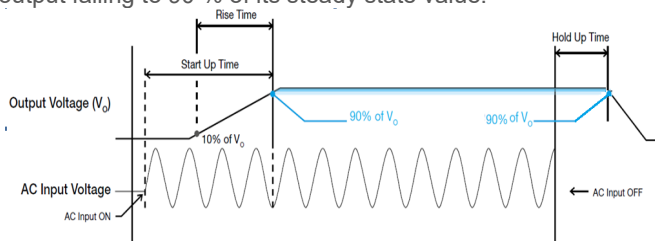

Figure 5 Time sequence

#### Dynamic Response (Main Output)

The power supply output voltage will remain within ± 5 % of its steady state value, when subjected to a dynamic load 50 % to 100 % of its rated current.

■ 50 % to 100 % Load

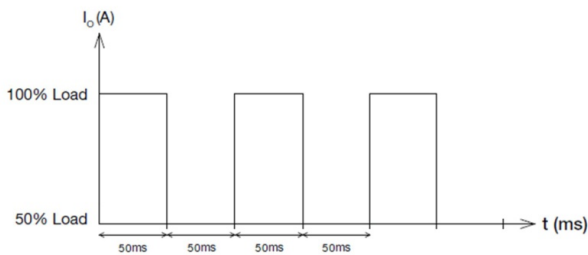

Figure 7 Dynamic Load

#### Inrush Current

Inrush current is the input current that occurs when the input voltage is first applied. For AC input voltages, the maximum peak value of inrush current will occur during the first half cycle of the applied AC voltage. This peak value decreases exponentially during subsequent cycles of AC voltage.

#### Overvoltage Protection

The power supply's overvoltage circuit will be activated when its internal feedback circuit fails. The output voltage shall not exceed its specifications defined on Page 5 under "Protections". Power supply will latch off, and require removal/re-application of input AC voltage in order to restart.

#### Overload & Over Current Protections

The power supply's Overload (OLP) and Over current (OCP) Protections will be activated before output current under 130 % of  $I_o$  (max. load). Upon such occurrence,  $V_o$  will start to drop. Once the power supply has reached its maximum power limit, the protection will be activated and the power supply will go into "Hiccup mode" (Auto-Recovery). The power supply will recover once the fault condition causing the OLP and OCP is removed and  $I_o$  is back within the specified limit.

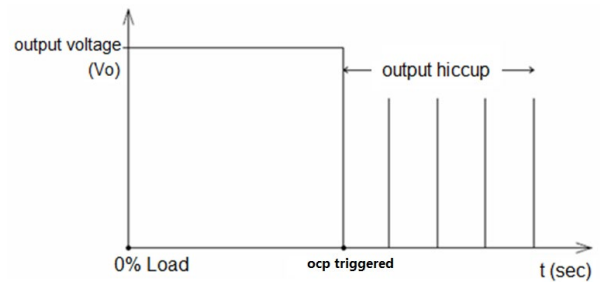

Figure 6. Hiccup at OLP/OCP

Additionally, if the load is > 100 % for a prolonged period of time (depending on the load), the Over Temperature Protection (OTP) may be activated due to high temperature on critical components. The power supply will then go into latch mode.

#### Short Circuit Protection

Output OLP/OCP function also provides protection against short circuits. When a short circuit is applied, the output current will operate in "Hiccup mode". The power supply will return to normal operation after the short circuit is removed.

#### Over Temperature Protection

As mentioned above, the power supply also has Over Temperature Protection (OTP). This is activated when the overload condition persists for an extended duration, and the output current is below the overload trigger point > 100 % load. In the event of a higher operating temperature condition at 100 % load, the power supply will run into OTP when the surrounding air temperature is higher than the operating temperature. When activated, the output voltage will go into latch mode until the input voltage is removed; then, re-applied, and the surrounding air temperature drops to its normal operating temperature.

# Medical / Industrial AC-DC Power Supply

## MEP-200A Series / 200 W, Convection Cooling and Low Profile

### Certificate



Delta has been certified as meeting the requirement of ISO 13485: 2003 and EN ISO 13485:2012 for the design and manufacture of switching power supply and adaptor for medical device.



In addition to a UL Total Certification Program (TCP) approved client laboratory for IEC60950 and IEC60065. Delta also has participated UL Client Test Data Program (CDTP) for IEC 60601

### Attention

Delta provides all information in the datasheets on an "AS IS" basis and does not offer any kind of warranty through the information for using the product. In the event of any discrepancy between the information in the catalog and datasheets, the datasheets shall prevail (please refer for the latest datasheets information). Delta shall have no liability of indemnification for any claim or action arising from any error for the provided information in the datasheets. Customer shall take its responsibility for evaluation of using the product before placing an order with Delta.

Delta reserves the right to make changes to the information described in the datasheets without notice.

### Manufacturer and Authorized Representatives Information

#### Manufacturer

##### Thailand

Delta Electronics (Thailand) PCL.  
909 Pattana 1 Rd., Muang, Samutprakarn, 10280 Thailand

##### Taiwan

Delta Electronics, Inc.  
3 Tungyuan Road, Chungli Industrial Zone, Taoyuan County  
32063, Taiwan

#### Authorized Representatives

##### The Netherlands

Delta Greentech (Netherlands) B.V.  
Zandsteen 15, 2132 MZ Hoofddorp, The Netherlands

##### United Kingdom

Delta Electronics Europe Limited  
1 Redwood Court, Peel Park Campus,  
East Kilbride, Glasgow, G74 5PF, United Kingdom