

Macroblock

Preliminary Datasheet

MBI5051

16-Channel PWM Constant Current LED Driver for 1:8 Time-multiplexing Applications

Features

- Backward compatible with MBI5050 in package
- 3V-5.5V supply voltage
- 16 constant current output channels
- Constant output current range:
 - 2~45mA @ 5V supply voltage
 - 2~30mA @ 3.3V supply voltage
- Excellent output current accuracy:
 - Between channels: $<\pm 1.5\%$ (typ.), and
 - Between ICs: $<\pm 3\%$ (typ.)
- Built-in 4K-bit SRAM to support time-multiplexing for 1 ~ 8 scans
- 16-bit /14-bit color depth PWM control to improve visual refresh rate
- LED open detection
- Integrating ghost elimination circuit
- GCLK multiplier technology
- Maximum DCLK frequency: 30MHz
- Staggered delay of output to reduce EMI

Small Outline Package

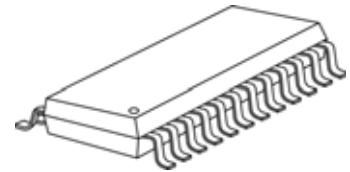

GF: SOP24L-236-1.00

Shrink SOP

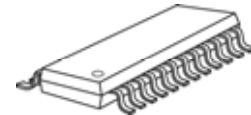

GP: SSOP24L-150-0.64

Product Description

MBI5051 is designed for LED video applications using internal Pulse Width Modulation (PWM) control with selectable 16-bit / 14-bit color depth. MBI5051 features a 16-bit shift register which converts serial input data into each pixel's gray scale of the output port. Sixteen regulated current ports are designed to provide uniform and constant current sinks for driving LEDs with a wide range of V_F variations. The output current can be preset through an external resistor. The innovative architecture with embedded SRAM is designed to support up to 1:8 time-multiplexing applications. Users only need to send the whole frame data once and to store in the embedded SRAM of the LED driver, instead of sending every time when the scan line is changed. It helps to save the data bandwidth and to achieve high grayscale with very low data clock rate. With scan-type Scrambled-PWM (S-PWM) technology, MBI5051 enhances PWM by scrambling the "on" time of each scan line into several "on" periods and sequentially drives each scan line for a short "on" period. The enhancement equivalently increases the visual refresh rate of scan-type LED displays. In addition, the innovative GCLK multiplier technique doubles visual refresh rate.

MBI5051 drives the corresponding LEDs to the brightness specified by image data. With MBI5051, all output channels can be built with 16-bit color depth (65,536 gray scales). When building a 16-bit color depth video, S-PWM technology reduces the flickers and improves the image fidelity.

Through compulsory error detection, MBI5051 detects individual LED for open-circuit errors without extra components. Besides, integrated ghost elimination circuit eases the ghost problems. For EMI reduction, constant current output with staggered delay is applied on each channel

MBI5051 16-Channel PWM Constant Current LED Driver for 1:8 Time-multiplexing Applications

Block Diagram

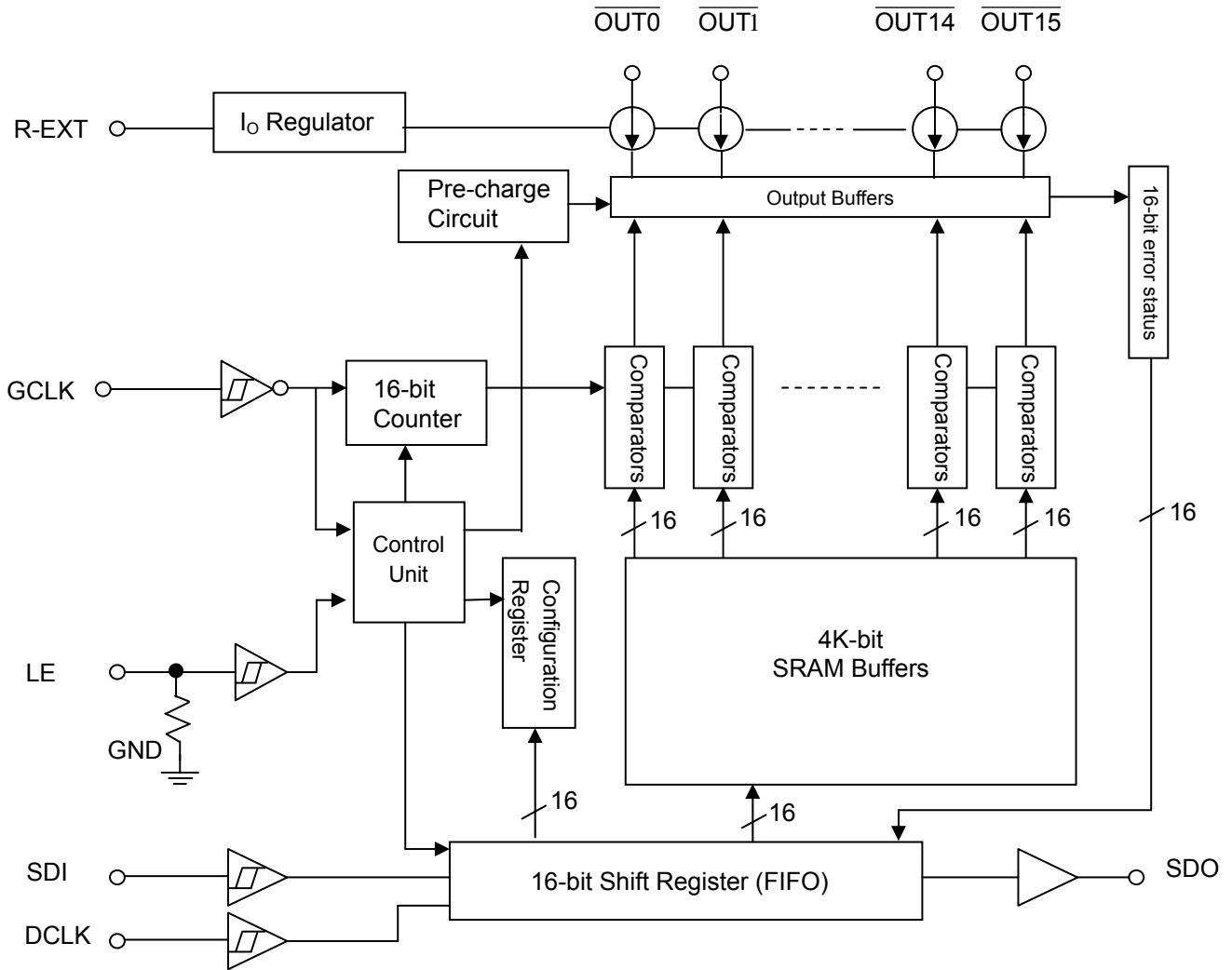

Figure 1

MBI5051**16-Channel PWM Constant Current LED Driver
for 1:8 Time-multiplexing Applications**

Pin Configuration

GND	1	24	VDD
SDI	2	23	R-EXT
DCLK	3	22	SDO
LE	4	21	GCLK
$\overline{\text{OUT0}}$	5	20	$\overline{\text{OUT15}}$
$\overline{\text{OUT1}}$	6	19	$\overline{\text{OUT14}}$
$\overline{\text{OUT2}}$	7	18	$\overline{\text{OUT13}}$
$\overline{\text{OUT3}}$	8	17	$\overline{\text{OUT12}}$
$\overline{\text{OUT4}}$	9	16	$\overline{\text{OUT11}}$
$\overline{\text{OUT5}}$	10	15	$\overline{\text{OUT10}}$
$\overline{\text{OUT6}}$	11	14	$\overline{\text{OUT9}}$
$\overline{\text{OUT7}}$	12	13	$\overline{\text{OUT8}}$

MBI5051 GF/GP

Terminal Description

Pin Name	Function
GND	Ground terminal for control logic and current sink
SDI	Serial-data input to the shift register
DCLK	Clock input terminal used to shift data on rising edge and carries command information when LE is asserted.
LE	Data strobe terminal and controlling command with DCLK
$\overline{\text{OUT0}} \sim \overline{\text{OUT15}}$	Constant current output terminals
GCLK	Gray scale clock terminal Clock input for gray scale. The gray scale display is counted by gray scale clock compared with input data.
SDO	Serial-data output to the receiver-end SDI of next LED driver
R-EXT	Input terminal used to connect an external resistor for setting up output current for all output channels
VDD	3.3V/5V supply voltage terminal

MBI5051 16-Channel PWM Constant Current LED Driver for 1:8 Time-multiplexing Applications

Equivalent Circuits of Inputs and Outputs

GCLK, DCLK, SDI terminal

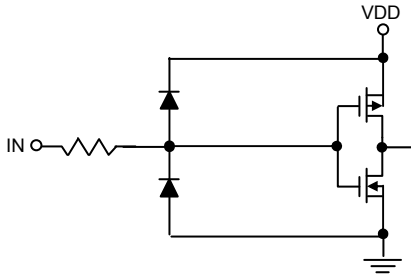

LE Terminal

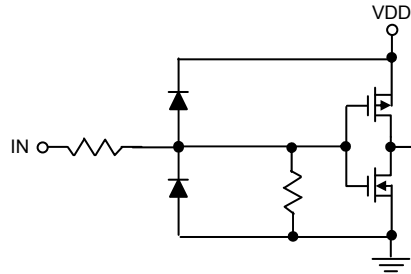

SDO Terminal

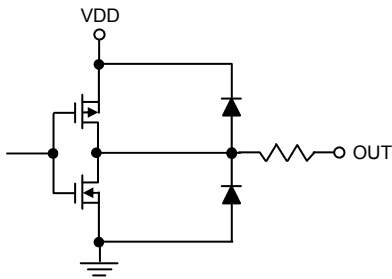

MBI5051 16-Channel PWM Constant Current LED Driver for 1:8 Time-multiplexing Applications

Maximum Rating

Characteristic		Symbol	Rating	Unit
Supply Voltage		V_{DD}	0~7	V
Input Pin Voltage (SDI)		V_{IN}	-0.4~ $V_{DD}+0.4$	V
Sustaining Voltage at OUT Port		V_{DS}	-0.5~17	V
Output Current		I_{OUT}	+45	mA
GND Terminal Current		I_{GND}	750	mA
Power Dissipation (On 4 Layer PCB, $T_a=25^{\circ}C$)*	GF Type	P_D	1.87	W
	GP Type		1.79	
Thermal Resistance (On 4 Layer PCB, $T_a=25^{\circ}C$)*	GF Type	$R_{th(j-a)}$	66.69	$^{\circ}C/W$
	GP Type		69.5	
Junction Temperature		$T_{j,max}$	150**	$^{\circ}C$
Operating Ambient Temperature		T_{opr}	-40~+85	$^{\circ}C$
Storage Temperature		T_{stg}	-55~+150	$^{\circ}C$

*The PCB size is 76.2mm*114.3mm in simulation. Please refer to JEDEC JESD51.

** Operation at the maximum rating for extended periods may reduce the device reliability; therefore, the suggested junction temperature of the device is under 125 $^{\circ}C$.

Note: The performance of thermal dissipation is strongly related to the size of thermal pad, thickness and layer numbers of the PCB. The empirical thermal resistance may be different from simulative value. User should plan for expected thermal dissipation performance by selecting package and arranging layout of the PCB to maximize the capability.

MBI5051**16-Channel PWM Constant Current LED Driver****for 1:8 Time-multiplexing Applications****Electrical Characteristics ($V_{DD}=5.0V$, $T_a=25^\circ C$)**

Characteristics		Symbol	Condition	Min.	Typ.	Max.	Unit	
Supply Voltage		V_{DD}	-	4.5	5.0	5.5	V	
Sustaining Voltage at OUT Ports		V_{DS}	$\overline{OUT0} \sim \overline{OUT15}$	-	-	17.0	V	
Output Current		I_{OUT}	Refer to "Test Circuit for Electrical Characteristics"	2	-	45	mA	
		I_{OH}	SDO	-	-	-1.0	mA	
		I_{OL}	SDO	-	-	1.0	mA	
Input Voltage	"H" level	V_{IH}	$T_a=-40\sim 85^\circ C$	$0.7 \times V_{DD}$	-	V_{DD}	V	
	"L" level	V_{IL}	$T_a=-40\sim 85^\circ C$	GND	-	$0.3 \times V_{DD}$	V	
Output Leakage Current		I_{OH}	$V_{DS}=17.0V$	-	-	0.5	μA	
Output Voltage	SDO	V_{OH}	$I_{OH}=-1.0mA$	$V_{DD}-0.4$	-	-	V	
		V_{OL}	$I_{OL}=+1.0mA$	-	-	0.4	V	
Current Skew (Channel)		dI_{OUT1}	$I_{OUT}=25mA$ $V_{DS}=1.0V$	$R_{ext}=560\Omega$	-	± 1.5	± 3.0	%
Current Skew (IC)		dI_{OUT2}	$I_{OUT}=25mA$ $V_{DS}=1.0V$	$R_{ext}=560\Omega$	-	± 3.0	± 6.0	%
Output Current vs. Output Voltage Regulation*		$\%/dV_{DS}$	V_{DS} within 1.0V and 3.0V, $R_{ext}=560\Omega @ 25mA$	-	± 0.1	± 0.5	% / V	
Output Current vs. Supply Voltage Regulation*		$\%/dV_{DD}$	V_{DD} within 4.5V and 5.5V	-	± 1.0	± 2.0	% / V	
LED Open Detection Threshold		$V_{OD,TH}$	-	-	0.3	-	V	
Pull-down Resistor		$R_{IN(down)}$	LE	250	450	800	K Ω	
Supply Current	"Off" (SDI=DCLK=GCLK=0Hz)	$I_{DD(off) 1}$	$R_{ext}=\text{Open}$, $\overline{OUT0} \sim \overline{OUT15} = \text{Off}$	-	3.4	6.0	mA	
		$I_{DD(off) 2}$	$R_{ext}=560\Omega$, $\overline{OUT0} \sim \overline{OUT15} = \text{Off}$	-	7.7	12		
		$I_{DD(off) 3}$	$R_{ext}=360\Omega$, $\overline{OUT0} \sim \overline{OUT15} = \text{Off}$	-	9.7	15		
	"On" (SDI=10MHz, DCLK=GCLK=20MHz)	$I_{DD(on) 1}$	$R_{ext}=560\Omega$, $\overline{OUT0} \sim \overline{OUT15} = \text{On}$	-	7.8	15		
		$I_{DD(on) 2}$	$R_{ext}=360\Omega$, $\overline{OUT0} \sim \overline{OUT15} = \text{On}$	-	9.8	20		

*One channel on.

MBI5051 16-Channel PWM Constant Current LED Driver for 1:8 Time-multiplexing Applications

Electrical Characteristics ($V_{DD}=3.3V, T_a=25^\circ C$)

Characteristics		Symbol	Condition	Min.	Typ.	Max.	Unit
Supply Voltage		V_{DD}	-	3.0	3.3	3.6	V
Sustaining Voltage at OUT Ports		V_{DS}	$\overline{OUT0} \sim \overline{OUT15}$	-	-	17.0	V
Output Current		I_{OUT}	Refer to "Test Circuit for Electrical Characteristics"	2	-	30	mA
		I_{OH}	SDO	-	-	-1.0	mA
		I_{OL}	SDO	-	-	1.0	mA
Input Voltage		"H" level V_{IH}	$T_a=-40\sim 85^\circ C$	$0.7 \times V_{DD}$	-	V_{DD}	V
		"L" level V_{IL}	$T_a=-40\sim 85^\circ C$	GND	-	$0.3 \times V_{DD}$	V
Output Leakage Current		I_{OH}	$V_{DS}=17.0V$	-	-	0.5	μA
Output Voltage		SDO	V_{OH} $I_{OH}=-1.0mA$	$V_{DD}-0.4$	-	-	V
			V_{OL} $I_{OL}=+1.0mA$	-	-	0.4	V
Current Skew (Channel)		dI_{OUT1}	$I_{OUT}=25mA$ $V_{DS}=1.0V$ $R_{ext}=560\Omega$	-	± 1.5	± 3.0	%
Current Skew (IC)		dI_{OUT2}	$I_{OUT}=25mA$ $V_{DS}=1.0V$ $R_{ext}=560\Omega$	-	± 3.0	± 6.0	%
Output Current vs. Output Voltage Regulation*		$\% / dV_{DS}$	V_{DS} within 1.0V and 3.0V, $R_{ext}=560\Omega @ 25mA$	-	± 0.1	± 0.5	% / V
Output Current vs. Supply Voltage Regulation*		$\% / dV_{DD}$	V_{DD} within 3.0V and 3.6V	-	± 1.0	± 2.0	% / V
LED Open Detection Threshold		$V_{OD,TH}$	-	-	0.3	-	V
Pull-down Resistor		$R_{IN(down)}$	LE	250	450	800	K Ω
Supply Current	"Off" (SDI=DCLK=GCLK=0Hz)	$I_{DD(off) 1}$	$R_{ext}=\text{Open}, \overline{OUT0} \sim \overline{OUT15} = \text{Off}$	-	3.2	6	mA
		$I_{DD(off) 2}$	$R_{ext}=560\Omega, \overline{OUT0} \sim \overline{OUT15} = \text{Off}$	-	7.4	12	
		$I_{DD(off) 3}$	$R_{ext}=360\Omega, \overline{OUT0} \sim \overline{OUT15} = \text{Off}$	-	9.4	15	
	"On" (SDI=10MHz, DCLK=GCLK=20MHz)	$I_{DD(on) 1}$	$R_{ext}=560\Omega, \overline{OUT0} \sim \overline{OUT15} = \text{On}$	-	7.4	15	
		$I_{DD(on) 2}$	$R_{ext}=360\Omega, \overline{OUT0} \sim \overline{OUT15} = \text{On}$	-	9.4	20	

*One channel on.

Test Circuit for Electrical Characteristics

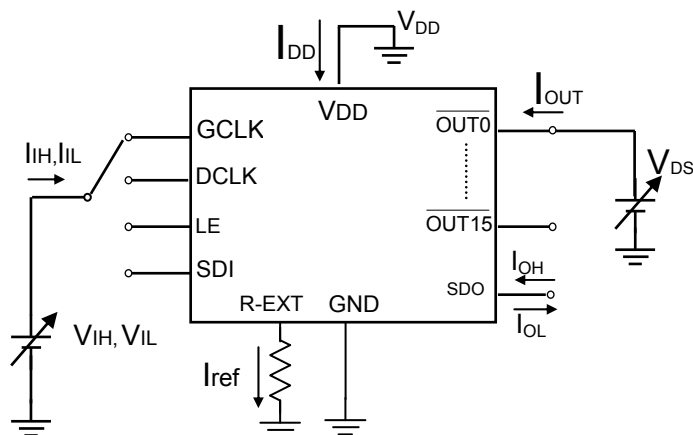

Figure 2

MBI5051**16-Channel PWM Constant Current LED Driver****for 1:8 Time-multiplexing Applications****Switching Characteristics ($V_{DD}=5.0V$)**

Characteristics		Symbol	Condition	Min.	Typ.	Max.	Unit
Setup Time	SDI - DCLK↑	t_{SU0}	$V_{DD}=5.0V$ $V_{IH}=V_{DD}$ $V_{IL}=GND$ $R_{ext}=680\Omega$ $V_{DS}=1V$ $R_L=150\Omega$ $C_L=10pF$ $C_1=100nF$ $C_2=10\mu F$ $C_{SDO}=10pF$ $V_{LED}=4.0V$	5	-	-	ns
	LE↑ - DCLK↑	t_{SU1}		8	-	-	ns
	LE (Vsync) - GCLK	t_{SU2}		8			ns
	LE↓ - DCLK↑	t_{SU3}		50			ns
Hold Time	DCLK↑ - SDI	t_{H0}		6	-	-	ns
	DCLK↑ - LE	t_{H1}		8	-	-	ns
	GCLK - LE↑(Vsync)	t_{H2}		7			ns
Propagation Delay Time	DCLK - SDO	t_{PD0}		-	22	25	ns
	GCLK - $\overline{OUT2n}$ *	t_{PD1}		-	35	-	ns
	LE - SDO	t_{PD2}^{***}		-	30	40	ns
Staggered Delay of Output	$\overline{OUT2n+1}$ **	t_{DL1}		-	5	-	ns
Pulse Width	LE	$t_{w(LE)}$		15			ns
Command to Command		Tcc		50	-	-	ns
Data Clock Frequency		F_{DCLK}		-	-	30	MHz
Gray Scale Clock Frequency****		F_{GCLK}		-	-	33	MHz
Min Clock(GCLK/DCLK) Pulse Width*****		$t_{w(CLK)}$		12	-	-	ns
Ratio of (GCLK freq)/(DCLK freq)		$R_{(GCLK/DCLK)}$	20	-	-	%	
Compulsory Error Detection Operation time*****		t_{ERR-C}	700	-	-	ns	
Output Rise Time of Output Ports		t_{OR}	-	15	20	ns	
Output Fall Time of Output Ports		t_{OF}	-	15	20	ns	

*Output waveforms have good uniformity among channels.

** Refer to the Timing Waveform, where n=0, 1, 2, 3, 4, 5, 6, 7.

***In timing of "configuration read", the next DCLK rising edge should be t_{PD2} after LE's falling edge.

****The Gray Scale Clock Frequency is 15MHz (max.) when the function of GCLK multiplier is enabled.

*****The Gray Scale Clock period must be 50% duty cycle when the function of GCLK multiplier is enabled.

*****Users have to leave more time than the maximum error detection time for the error detection.

MBI5051**16-Channel PWM Constant Current LED Driver****for 1:8 Time-multiplexing Applications****Switching Characteristics ($V_{DD}=3.3V$)**

Characteristics		Symbol	Condition	Min.	Typ.	Max.	Unit
Setup Time	SDI - DCLK↑	t_{SU0}	$V_{DD}=3.3V$ $V_{IH}=V_{DD}$ $V_{IL}=GND$ $R_{ext}=680\Omega$ $V_{DS}=1V$ $R_L=150\Omega$ $C_L=10pF$ $C_1=100nF$ $C_2=10\mu F$ $C_{SDO}=10pF$ $V_{LED}=4.0V$	7	-	-	ns
	LE - DCLK↑	t_{SU1}		10	-	-	ns
	LE (Vsync) - GCLK	t_{SU2}		10			ns
	LE↓ - DCLK↑	t_{SU3}		52			ns
Hold Time	DCLK↑ - SDI	t_{H0}		8	-	-	ns
	DCLK↑ - LE	t_{H1}		10	-	-	ns
	GCLK - LE↑(Vsync)	t_{H2}		10			ns
Propagation Delay Time	DCLK - SDO	t_{PD0}		-	25	30	ns
	GCLK - $\overline{OUT2n^*}$	t_{PD1}		-	45	-	ns
	LE - SDO	t_{PD2}^{***}		-	40	50	ns
Staggered Delay of Output	$\overline{OUT2n+1}^{**}$	t_{DL1}		-	8	-	ns
Pulse Width	LE	$t_{w(LE)}$		16			ns
Command to Command		t_{CC}		52	-	-	ns
Data Clock Frequency		F_{DCLK}		-	-	25	MHz
Gray Scale Clock Frequency****		F_{GCLK}		-	-	20	MHz
Min Clock(GCLK/DCLK) Pulse Width*****		$t_{w(CLK)}$		13			ns
Ratio of (GCLK freq)/(DCLK freq)		$R_{(GCLK/DCLK)}$	20		-	%	
Compulsory Error Detection Operation time*****		t_{ERR-C}	700	-	-	ns	
Output Rise Time of Output Ports		t_{OR}		20	25	ns	
Output Fall Time of Output Ports		t_{OF}		20	25	ns	

*Output waveforms have good uniformity among channels.

** Refer to the Timing Waveform, where n=0, 1, 2, 3, 4, 5, 6, 7.

***In timing of "configuration read", the next DCLK rising edge should be t_{PD2} after LE's falling edge.

****The Gray Scale Clock Frequency is 10MHz (max.) when the function of GCLK multiplier is enabled.

*****The Gray Scale Clock period must be 50% duty cycle when the function of GCLK multiplier is enabled.

*****Users have to leave more time than the maximum error detection time for the error detection.

MBI5051 16-Channel PWM Constant Current LED Driver for 1:8 Time-multiplexing Applications

Test Circuit for Switching Characteristics

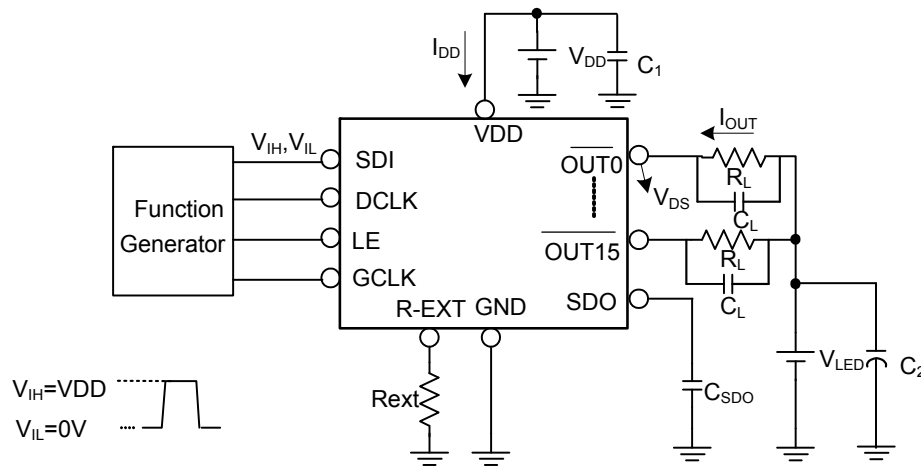
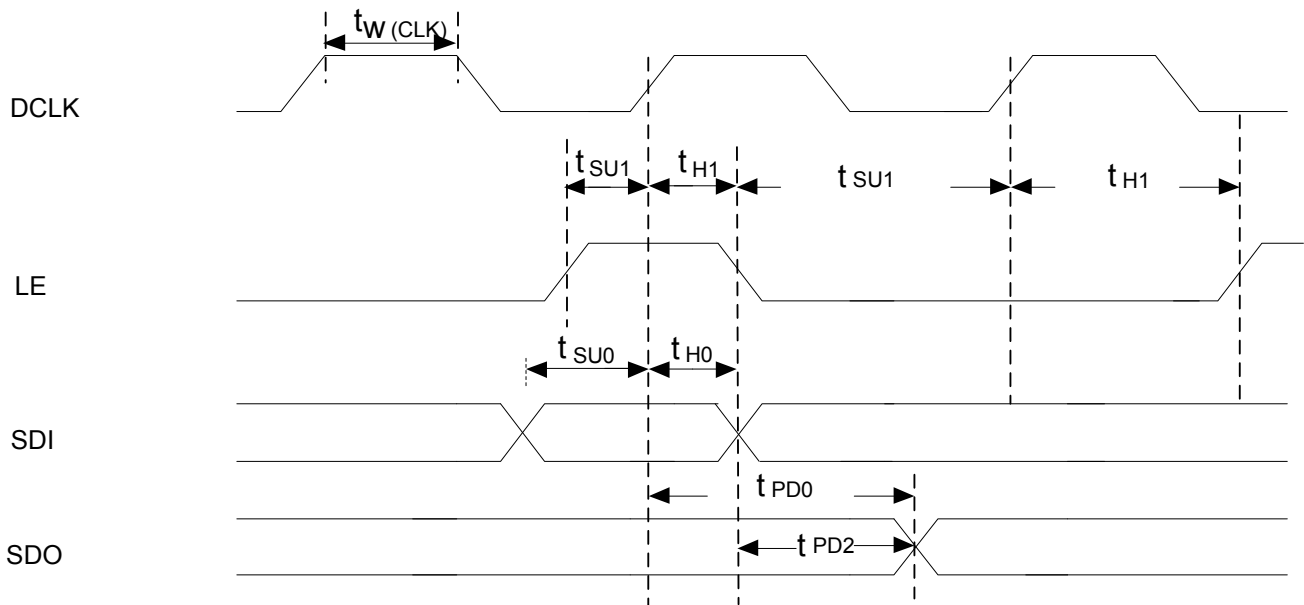

Figure 3

MBI5051 16-Channel PWM Constant Current LED Driver for 1:8 Time-multiplexing Applications

Timing Waveform

(1)



(2)

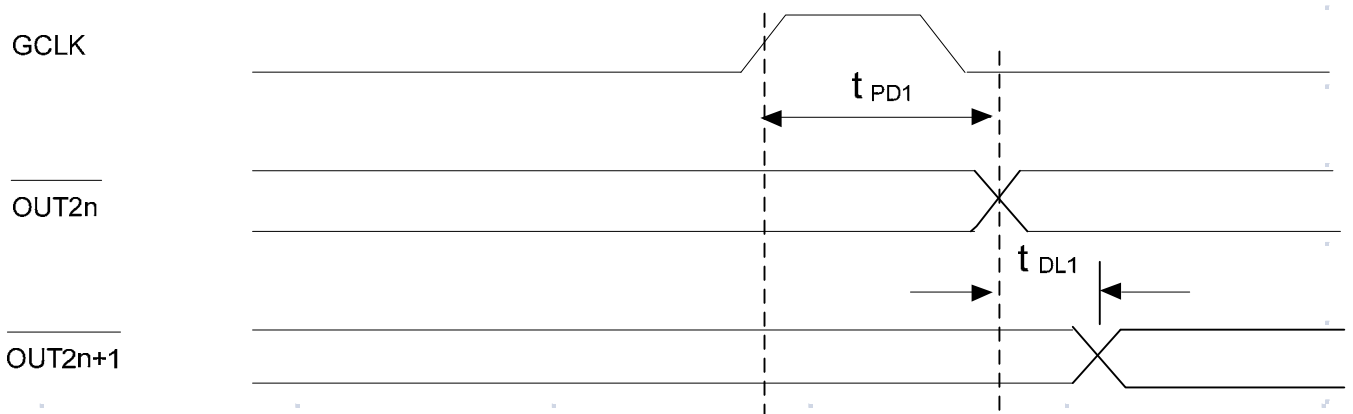

(3)

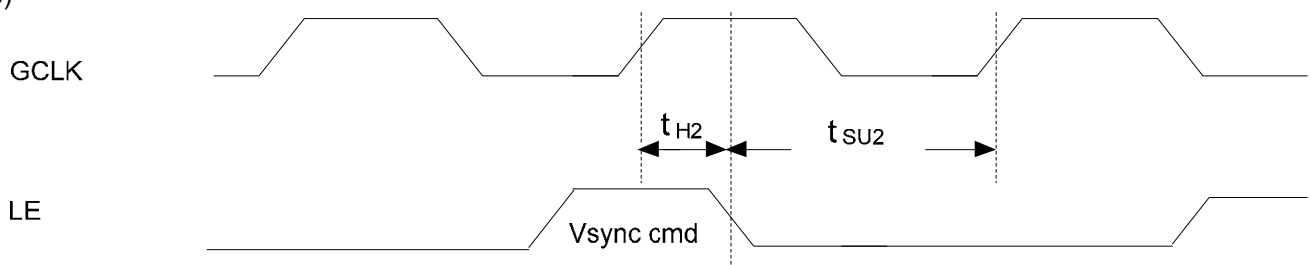

MBI5051 16-Channel PWM Constant Current LED Driver for 1:8 Time-multiplexing Applications

(4)

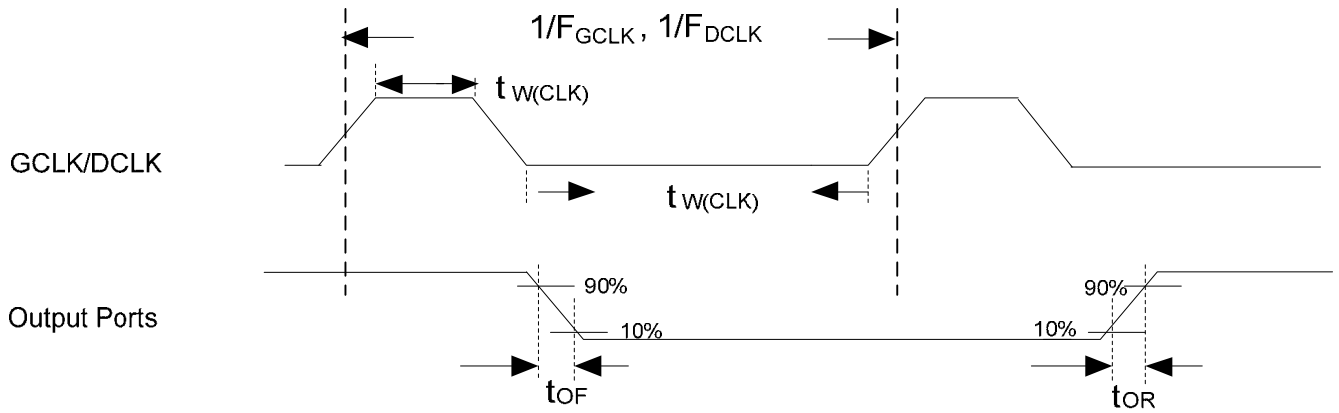

(5)

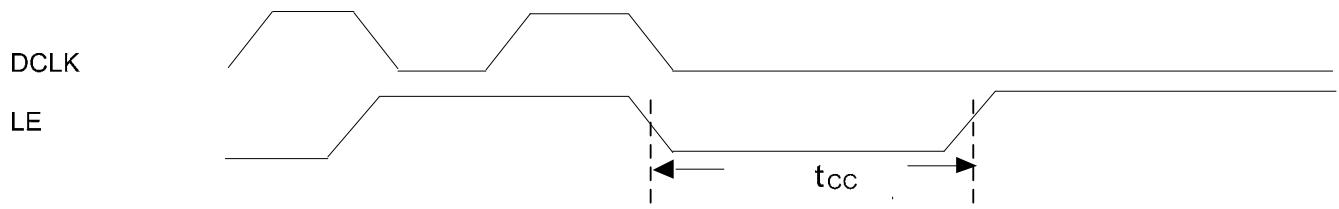

(6)

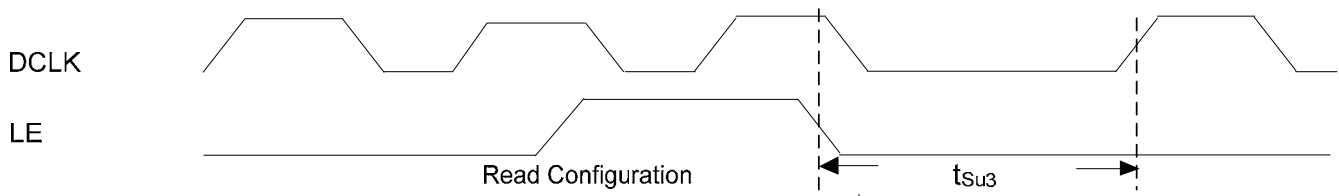

MBI5051 16-Channel PWM Constant Current LED Driver for 1:8 Time-multiplexing Applications

Control Command

Command Name	Signals Combination		Description
	LE	Number of DCLK Rising Edge when LE is asserted	
Stop Compulsory Error detection	High	1	Stop compulsory error detection.
Data Latch	High	1	Serial data are transferred to the input data buffers.
Vsync	High	3	Vertical Synchronal signal. Displaying frame will be updated to output channel.
Write Configuration*	High	4	Serial data are written to the configuration register.
Read Configuration	High	5	Serial data are read from the configuration register.
Start Compulsory Error detection	High	7	Start compulsory LED open detection
Software Reset	High	10	Reset the behavior of MBI5051 except the value of configuration registers.
Pre-Active	High	14	Pre-Active command needs to be sent before "Write Configuration" command.

*Those commands can only be activated after Pre-Active command; otherwise, they will be invalid.

Note: When the power is on, Vsync command will be valid only after 16 times of "Data Latch" commands that have been sent in advance.

The following figures show the waveforms of commands which require or don't require "Pre-Active" ahead.

Commands which don't require Pre-Active ahead

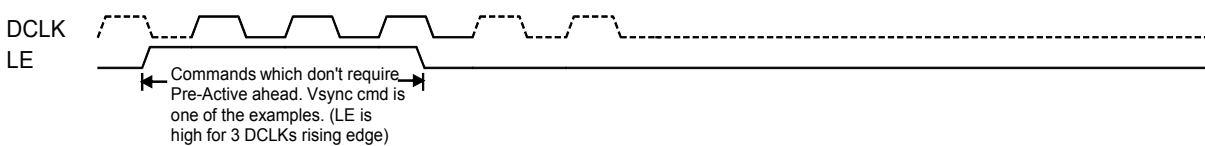

Commands which require Pre-Active ahead

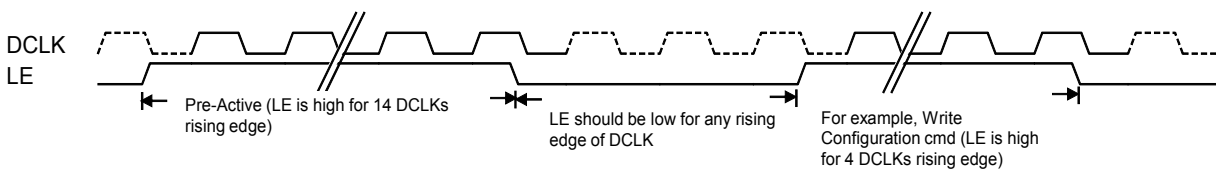

MBI5051 16-Channel PWM Constant Current LED Driver for 1:8 Time-multiplexing Applications

Waveform of Commands

The following figures show the waveforms of each command.

Data Latch

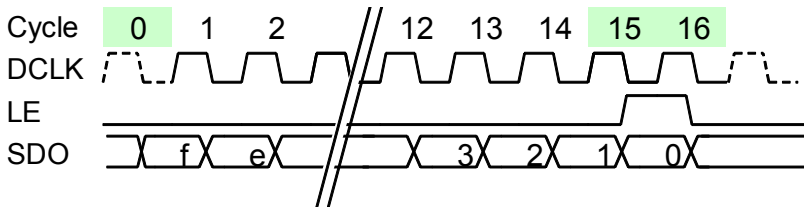

Data Latch command is used to latch the 16-bit shift register from SDI to internal SRAM buffer. When this command is received, the last 16 bits data before the falling edge of LE will be latched into SRAM, as shown in the above waveform, and MSB bit needs to be sent first.

Vertical Sync

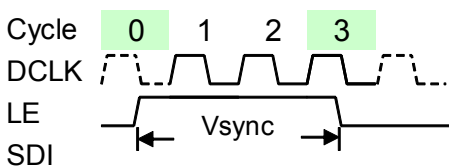

“Vsync” command is used to update frame data on output channels ($\overline{OUT0} \sim \overline{OUT15}$). There are some timing limitations between signal “LE” and “GCLK”; and please refer to the section of “Vsync Command Operation” for details.

Note: The extra DCLK after LE goes low is required for GCLK DCLK mode. Please refer to “Vsync Command Operation” for detailed information.

Write Configuration

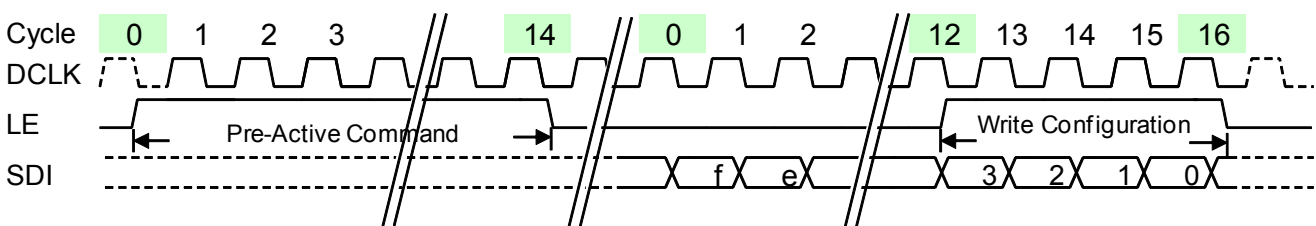

“Write configuration” command is used to program the configuration register of MBI5051. The “Pre-Active” command must be sent in advance. When this command is received, the last 16 bits data before the falling edge of LE will be latched into configuration register, as shown in the above waveform, and MSB bit needs to be sent first.

MBI5051 16-Channel PWM Constant Current LED Driver for 1:8 Time-multiplexing Applications

Read Configuration

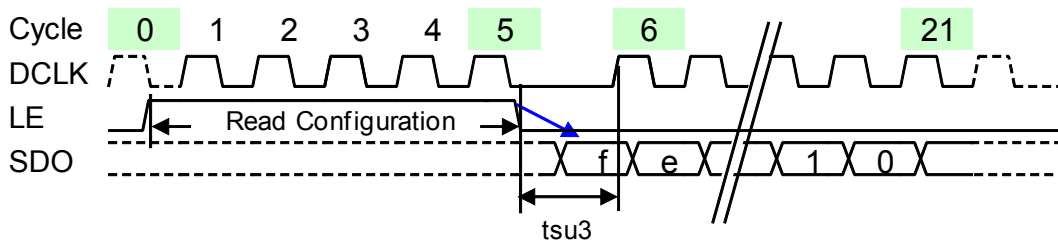

“Read configuration” command is used to read the configuration register of MBI5051. When this command is received, the 16-bit data of configuration register will be shifted out from SDO pin, as shown in the above waveform, and MSB bit will be shifted out first.

Software Reset

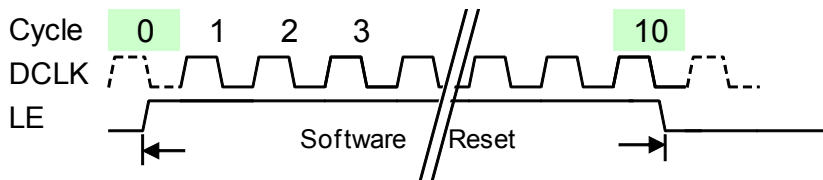

“Software reset” command makes MBI5051 go back to the initial state except configuration register value. After this command is received, the output channels will be turned off and will display again with last gray-scale value after new “Vsync” command is received.

MBI5051 16-Channel PWM Constant Current LED Driver

for 1:8 Time-multiplexing Applications

Definition of Configuration Register

MSB

LSB

F	E	D	C	B	A	9	8	7	6	5	4	3	2	1	0
---	---	---	---	---	---	---	---	---	---	---	---	---	---	---	---

e.g. Default Value

F	E	D	C	B	A	9	8	7	6	5	4	3	2	1	0
0	0	0	0	0	0	1	1	0	0	6'b101011					

Default setting of configuration register is 16'h032B

Bit	Attribute	Definition	Value	Function
F	Read/Write	Lower ghost elimination	0 (Default)	0:Disable
				1:Enabled
E	Read/Write	Upper ghost elimination	0(default)	0:Disable
				1:Enabled
D	Read/Write	GCLK source	0 (Default)	0:GCLK sent by user
				1:Set GCLK=DCLK. Use DCLK to be the source of GCLK.
C	Reserved	Reserved	0 (Default)	Please keep "0"
B	Read/Write	Stagger delay on / off	0 (Default)	0:Enabled
				1:Disable
A-8	Read/Write	Number of scan lines	000 001 010 011 (Default) ~ 111	000: 1 lines 001: 2 lines 010: 3 lines 011: 4 lines 100: 5 lines 101: 6 lines 110: 7 lines 111: 8 lines
7	Read/Write	Gray scale mode	0 (Default)	The 65536 GCLKs (16-bit) PWM cycle is divided into 64 sections, each section has 1024 GCLKs.
			1	The 16384 GCLKs(14-bit) PWM cycle is divided into 16 sections, each section has 1024 GCLKs., User still sends 16-bit data with 2 bit 0 in LSB bits.
6	Read/Write	GCLK multiplier	0 (Default)	GCLK multiplier disable
			1	GCLK multiplier enable
5~0	Reserved	Reserved	101011	Please keep 6'b101011 It is suggested to write 6'b101011 again after power on reset (POR)

MBI5051 16-Channel PWM Constant Current LED Driver for 1:8 Time-multiplexing Applications

Number of Scan Line

MBI5051 supports 1 to 8 scan lines. Please set the configuration register bit [A:8] according to the application. The default value '011' is 4 scan lines.

Gray Scale Mode and Scan-type S-PWM

MBI5051 provides a selectable 16-bit or 14-bit gray scale by setting the configuration register bit [7]. The default value is set to '0' for 16-bit color depth. In 14-bit gray scale mode, users should still send 16-bit data with 2-bit '0' in LSB bits. For example, {14'h1234, 2'h0}.

MBI5051 has a smart S-PWM technology for scan type. With S-PWM, the total PWM cycles can be broken into MSB (Most Significant Bits) and LSB (Least Significant Bits) of gray scale cycles. The MSB information can be broken down into many refresh cycles to achieve overall same high bit resolution.

GCLK multiplier disabled (configuration register bit[6]="0")

Display sequence of 64 scrambles

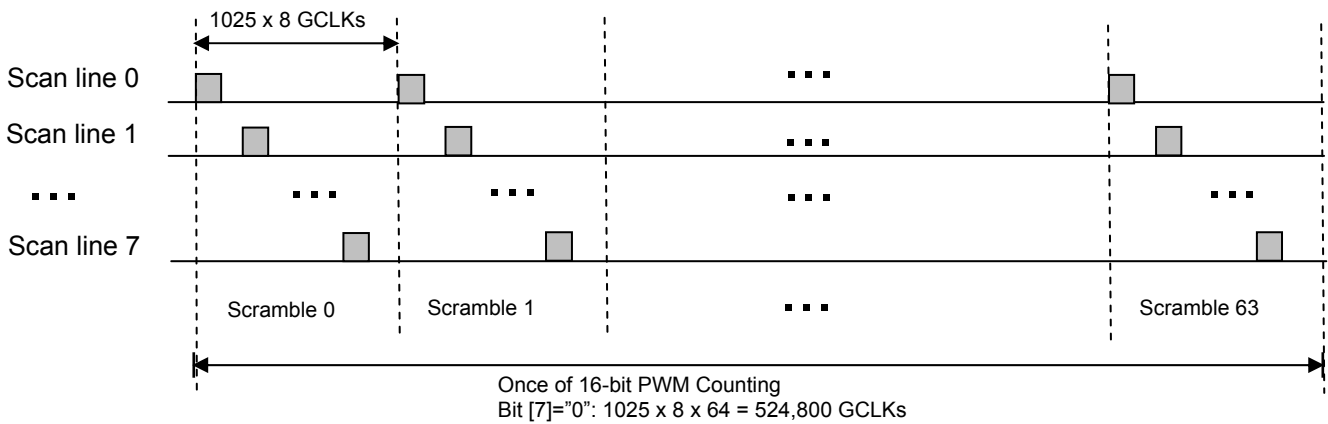

█ : Output ports are turned "on".

GCLK multiplier disabled (configuration register bit[6]="0")

Display sequence of 16 scrambles,

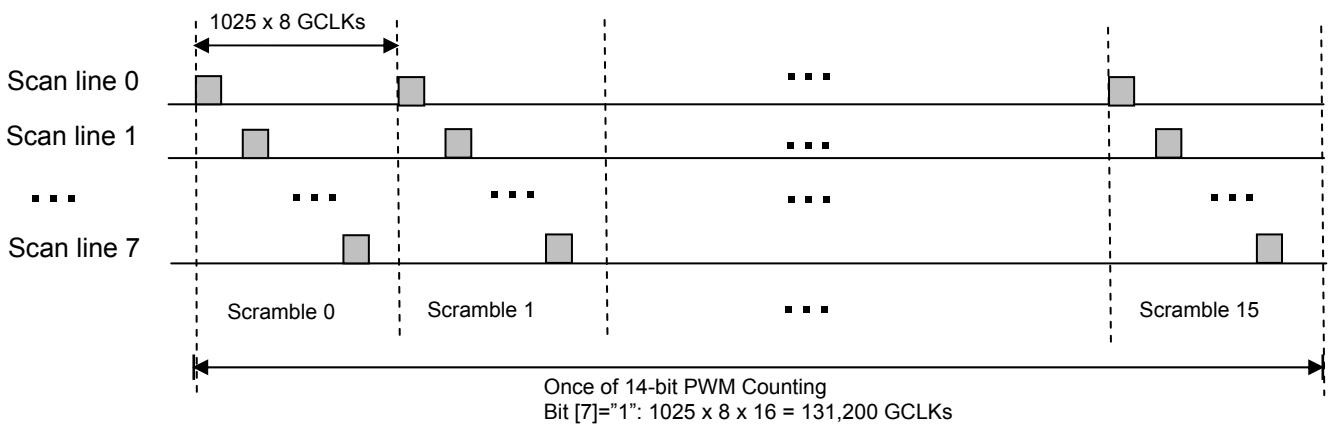

█ : Output ports are turned "on".

MBI5051 16-Channel PWM Constant Current LED Driver for 1:8 Time-multiplexing Applications

GCLK multiplier enabled (configuration register bit[6]="1")

Display sequence of 64 scrambles

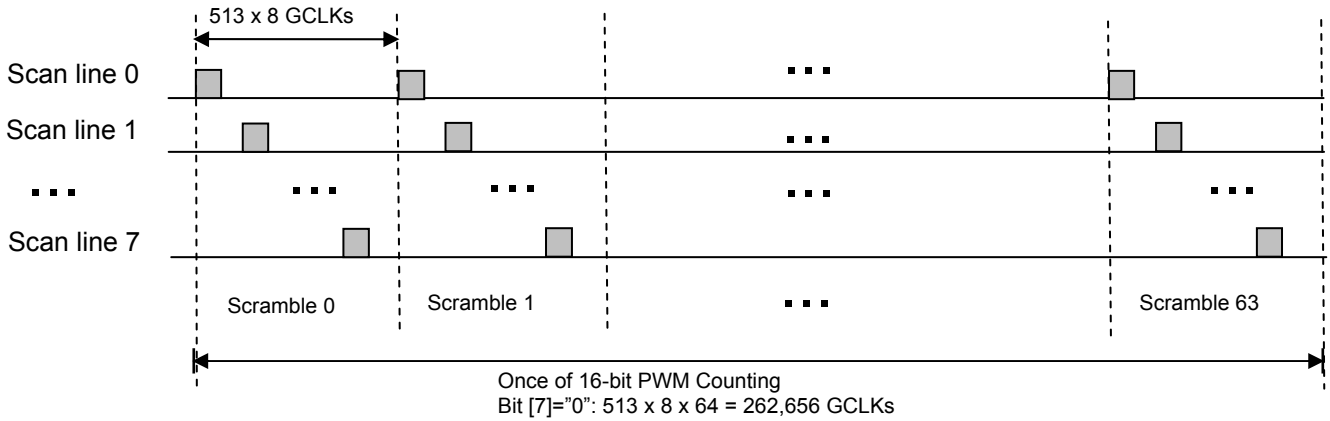

█ : Output ports are turned "on".

GCLK multiplier enabled (configuration register bit[6]="1")

Display sequence of 16 scrambles

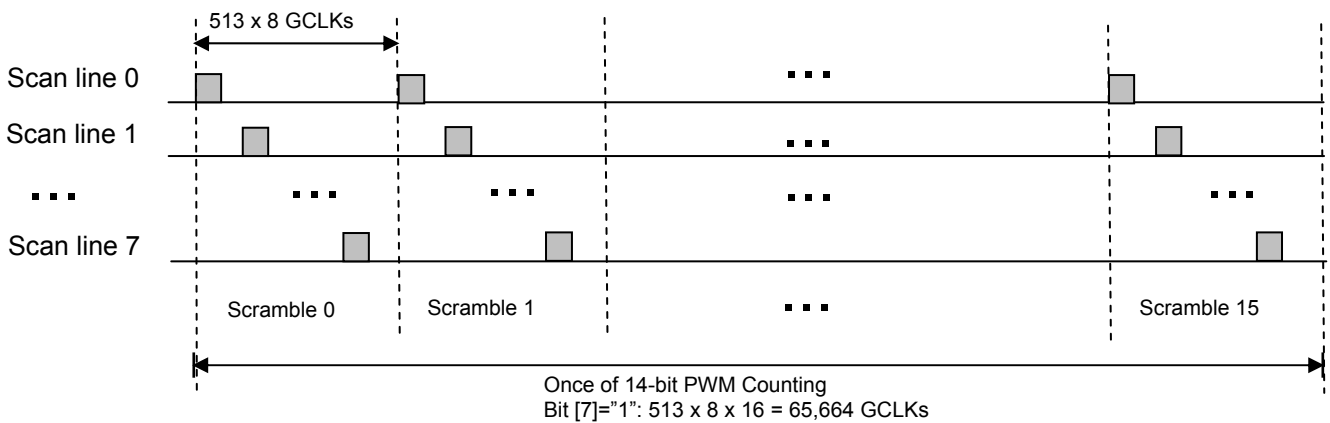

█ : Output ports are turned "on".

GCLK Source

Users could choose GCLK source by setting the configuration register bit [D]. The default value is '0' that GCLK is controlled by users. The GCLK tracing on PCB could be saved by choosing GCLK=DCLK.

MBI5051 16-Channel PWM Constant Current LED Driver for 1:8 Time-multiplexing Applications

Operation Principal

Scan type application structure

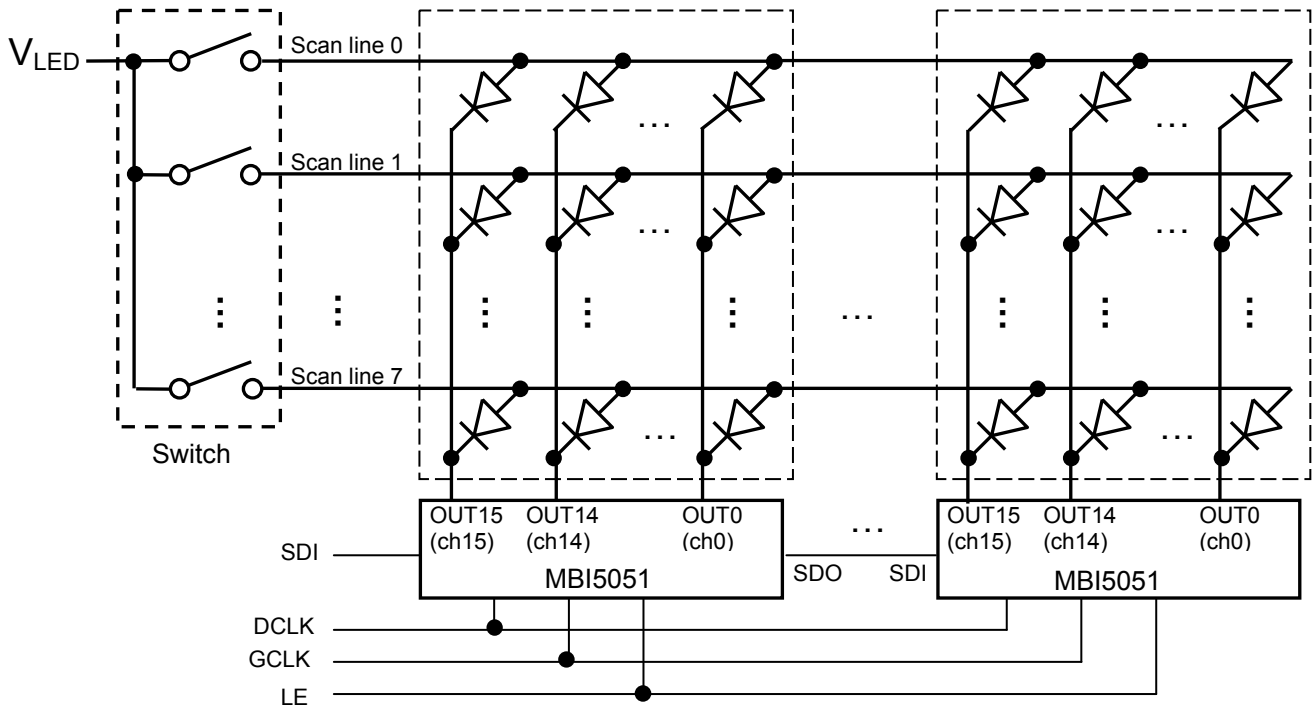

The above figure shows the suggested application structure of scan type scheme with 8 scan lines. The gray-scale data are sent by pin “SDI and SDO” with the commands formed by pin “LE” and “DCLK”. The output ports from 16 channels (OUT0~OUT15) will output the PWM result for each scan line at different time, so there must be one “Switch” to multiplex for each scan line. The switching sequence and method and the command usage will be described in the following section.

MBI5051 16-Channel PWM Constant Current LED Driver for 1:8 Time-multiplexing Applications

Initialization Sequence

At initialization, users need to program the configuration register, if the default value of the register is not what they want. Then, the users need to send the gray scale data by the number of "Data Latch" commands (16 x number of scan lines), and then send one Vsync command to start to display.

For the initial sequence, users should only send Vsync command after 50 GCLKs of the last "Data Latch" command as shown in the below waveform. The display data will not start until first Vsync command is ready. The GCLK must be stopped before Vsync command is set, and there are some timing limitations which will be described in detail in the following section.

Start to display data for initial case

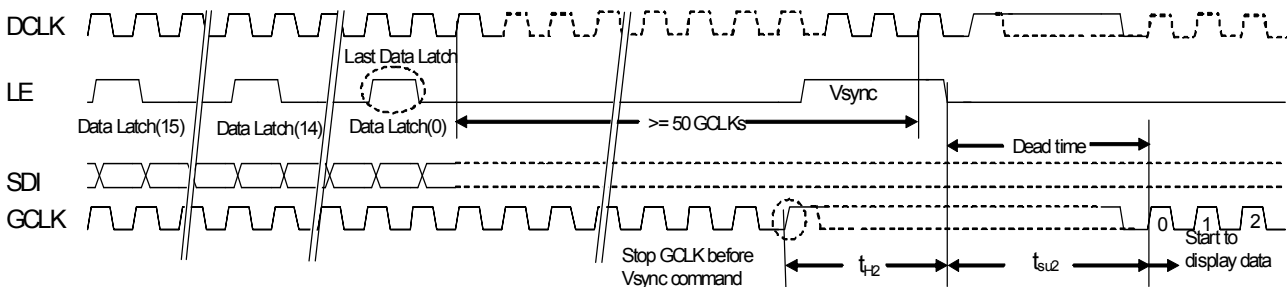

Vsync Command Operation

"Vsync" command is set when users want to update the image frame. Below waveforms show the Vsync command to update the frame, when GCLK is independent of or equal to DCLK.

If GCLK ≠ DCLK:

Update new frame for Vsync (GCLK DCLK)

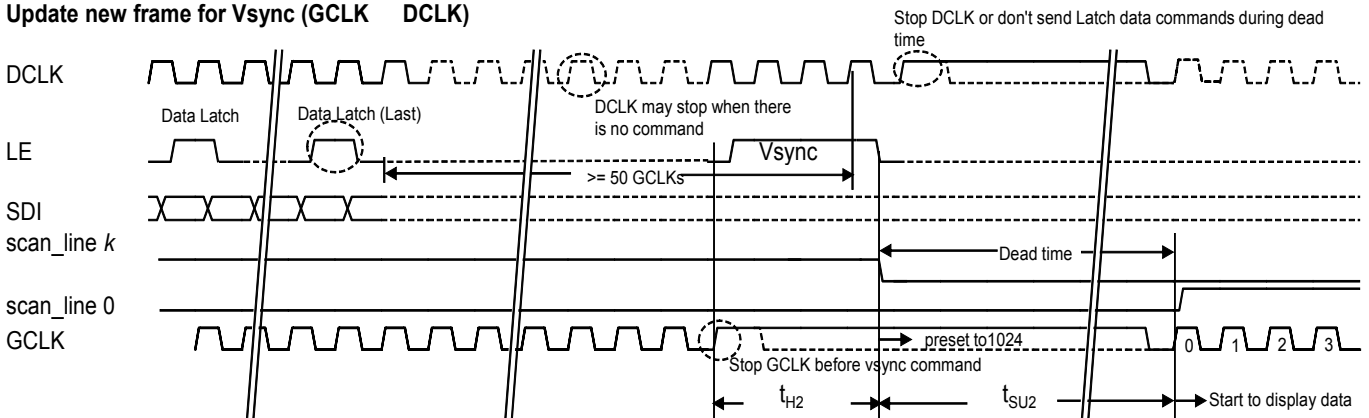

There are limitations for users to follow:

- a.) Since the gray scale data needs time to pre-read from SRAM to internal display buffer after last Data Latch command, there should be at least 50 GCLKs before the Vsync command is sent
 Note: More details about SRAM memory structure can be referred to the section of Memory Structure.
- b.) It is suggested for controller to keep one GCLK counter (from 0~1024), which will preset to 1024 at the falling edge of LE of Vsync command and restart from 0 at next GCLK.
- c.) Since Vsync is the LE clock domain, there is a timing limitation between LE and GCLK. The GCLK should stop before Vsync command is sent. The setup and hold time between LE's falling edge and GCLK's rising edge must meet the t_{SU2} and t_{H2} , respectively.

MBI5051 16-Channel PWM Constant Current LED Driver for 1:8 Time-multiplexing Applications

- d.) The GCLK also needs to stop for dead time. The dead time is the time interval between scan lines, and is controlled by stopping GCLK. When Vsync command is set, the frame will be updated. The scan line needs to be switched (by controller) from scan line k to scan line 0, too.
- e.) DCLK can either stop or not when there is no command.
- f.) During dead time, user needs to either stop DCLK or cannot send "Data Latch" command.
- g.) The new data will be loaded to internal display buffer at Vsync command. But it will start to display after dead time is finished.

If GCLK = DCLK

The control behavior is a little different from above:

- a.) The DCLK cannot stop after finishing sending command due to DCLK also acts as GCLK.
- b.) The DCLK needs to stop after finishing sending Vsync command for dead time. Of course, the setup and hold time between LE's falling edge and GCLK's rising edge must meet the t_{SU2} and t_{H2} , too.
- c.) The stop point of DCLK for Vsync command can only be set before GCLK counter is < 1023 .

Update new frame for Vsync (GCLK = DCLK)

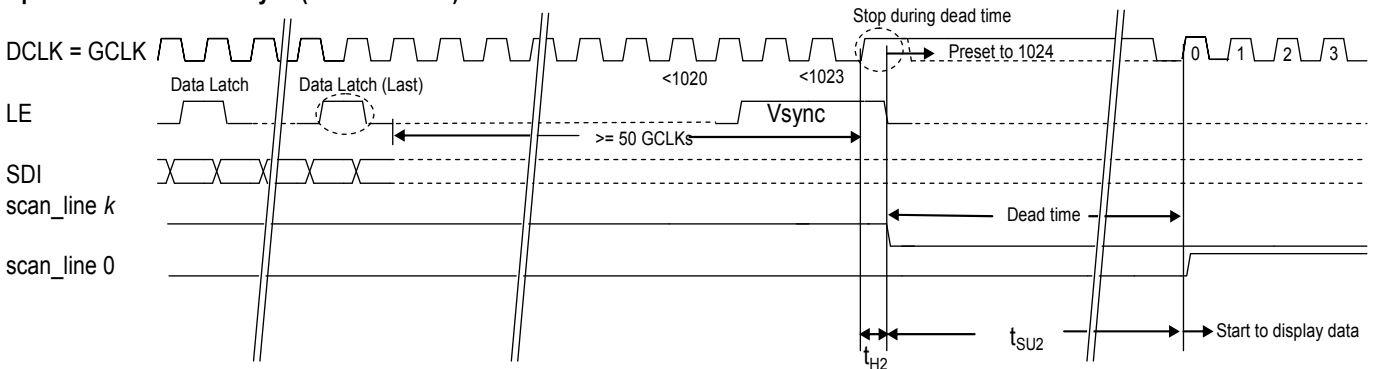

Switch Scan Line Inside Each Frame

For the control of scan line switch, users should count in the same way of MBI5051's GCLK counter and switch each scan line when MBI5051 GCLK counter counts to 1023, and please refer to the section of Gray Scale Mode and Scan-type S-PWM for the multiplexing sequence. The dead time is controlled by stopping GCLK. MBI5051 will turn off output channels when GCLK counter value equals to 1024 during dead time.

Update scan line every 1025 GCLKs

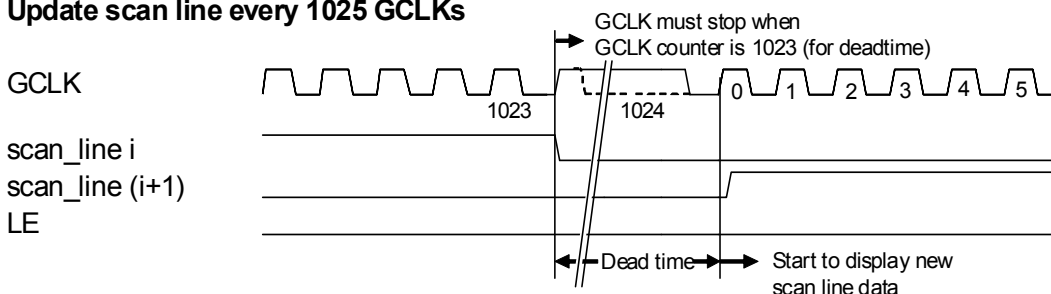

Summary

The control sequence is described as below:

1. Users program the configuration register by "Write Configuration" command.
2. Users send gray scale data by the number of "Data Latch" commands (16 x number of scan lines).

MBI5051 16-Channel PWM Constant Current LED Driver for 1:8 Time-multiplexing Applications

- After last "Data Latch" command, users must wait for more than 50 GCLKs before sending Vsync command. If it is not the first frame, users should send Vsync command according to the frame rate. For example, if the frame rate is 60, users should wait for 1/60 seconds. When users send Vsync command, the related timing limitations must be followed.
- When users send Vsync command, the scan line needs to start to count from 0. GCLK counter needs to be pre-set to 1024 and stops GCLK for dead time.
- During the frame display period, users need to keep one GCLK counter (0~1024) and switch scan line and insert dead time (by stopping GCLK) when GCLK counter counts to 1023.
- During dead time (both for sending Vsync command or when GCLK counter equals to 1024), it's not allowed to send "Data Latch" command.
- The gray scale data of the next frame may be sent after Vsync command is sent.
- It's strongly recommend that "Write Configuration" command should be sent periodically to avoid system noise interference.

Visual Refresh Rate

In 16-bit S-PWM mode, the visual refresh rate will be improved by 64x, if the data is 64.

In 14-bit S-PWM mode, the visual refresh rate will be improved by 16x, if the data is 16.

The formula of visual refresh rate is:

In 16-bit S-PWM mode, visual refresh rate = GCLK frequency / [(1024 GCLK + dead time) x number of scan lines]

In 14-bit S-PWM mode, visual refresh rate = GCLK frequency / [(1024 GCLK + dead time) x number of scan lines]

For example, if there are 8 scan lines with 16-bit scan-type S-PWM, the GCLK frequency is 10MHz. The dead time is 10 GCLK periods. Then the visual refresh rate could be calculated as below:

Visual refresh rate = 10MHz / [(1024+10) x 8] = 1208Hz.

Data Input Sequence

The sequence of input data starts from scan line 0 first, then scan line 1, and so on.

During each scan line, gray-scale data of channel 15 needs to be sent first, and then channel 14, continuously to channel 0.

Please refer to the section of scan type application structure for scan type scheme.

The following examples are the waveforms with 1 LED driver and 2 cascaded LED drivers respectively.

1x IC, 8 scan lines

For only one LED driver used, there are 14 bits for each channel, and note that MSB bit is sent first. Please note \ 2-bit '0' in LSB bits is necessary in 14-bit mode.

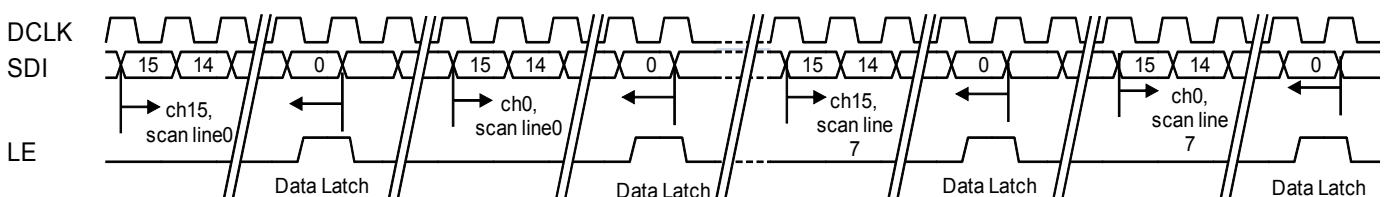

MBI5051 16-Channel PWM Constant Current LED Driver for 1:8 Time-multiplexing Applications

2x ICs, 8 scan lines

For two LED drivers cascaded, there are 16 bits for each LED driver, so there are 32 bits for each channels, first 16 bits (bit31 ~ bit16) is for 2nd LED driver, and last 16 bits (bit15 ~ bit0) is for 1st LED driver, note that MSB bit is sent first, too.

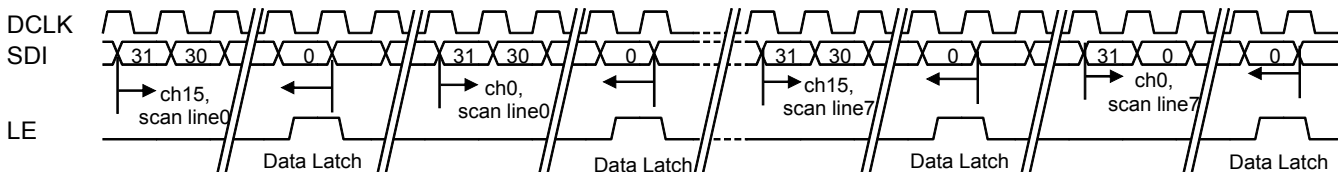

LED Open Error Detection

The principle of MBI5051 LED open-circuit detection is based on the fact that the LED loading status is judged by comparing the effective voltage value (V_{DS}) of each output port with the target voltage ($V_{DS,TH}$) = 0.3V. Thus, after the command of "error detection", MBI5051 performs compulsory error detection when receiving one LE pulse with 7 DCLKs and stops the error detection when receiving one LE pulse with 1 DCLK. Besides, the output channels will be forced to turn off to perform the compulsory error detection. The duration is suggested longer than 700ns (between the LE falling edges). The error report will be pushed out after the compulsory error detection operation time. MBI5051 will shift out MSB of LED open reports to LSB of LED open reports from SDO simultaneously.

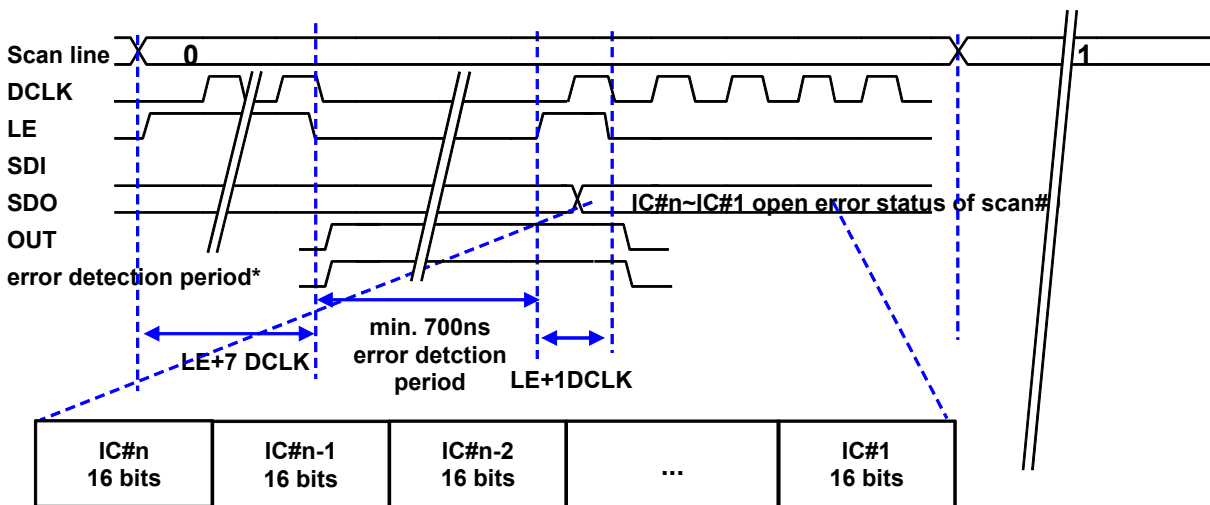

MBI5051 16-Channel PWM Constant Current LED Driver for 1:8 Time-multiplexing Applications

Constant Current

In LED display application, MBI5051 provides nearly no variation in current from channel to channel and from IC to IC. This can be achieved by:

- 1) The typical current variation between channels is less than 1.5%, and that between ICs is less than $\pm 3\%$.
- 2) In addition, the current characteristic of output stage is flat and user can refer to the figure below. The output current can be kept constant regardless of the variations of LED forward voltages (V_F). This guarantees LED to be performed on the same brightness as user's specification.

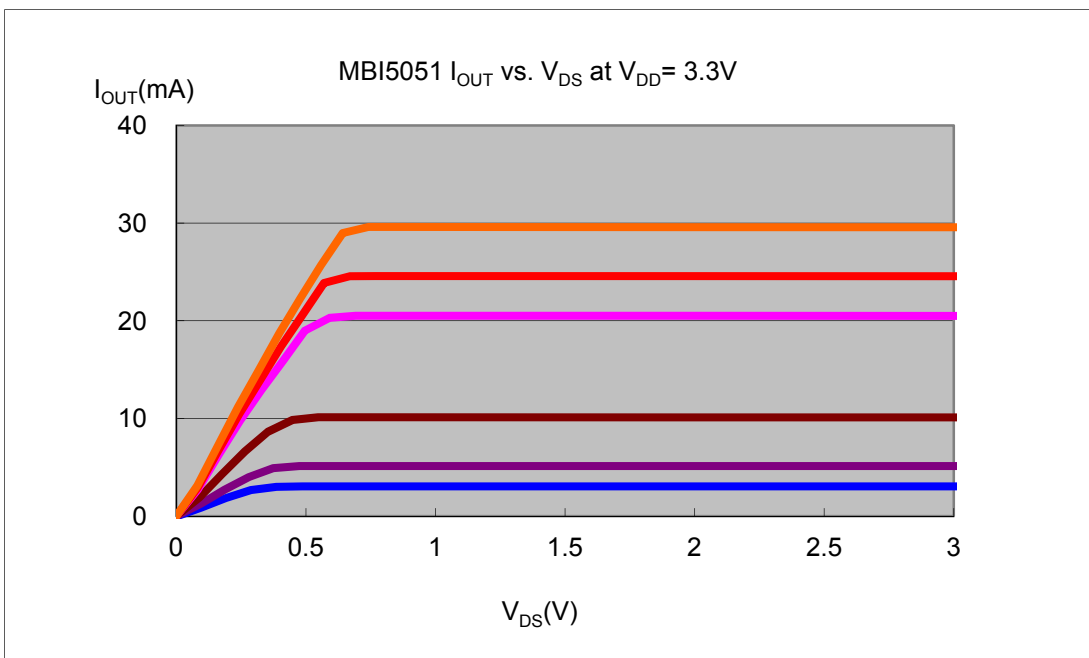
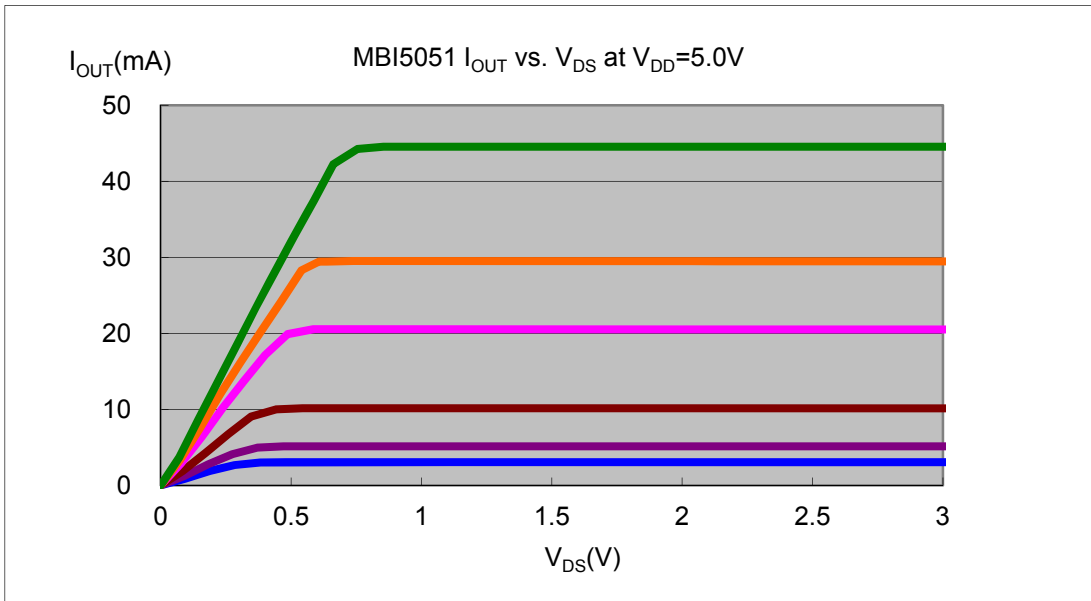
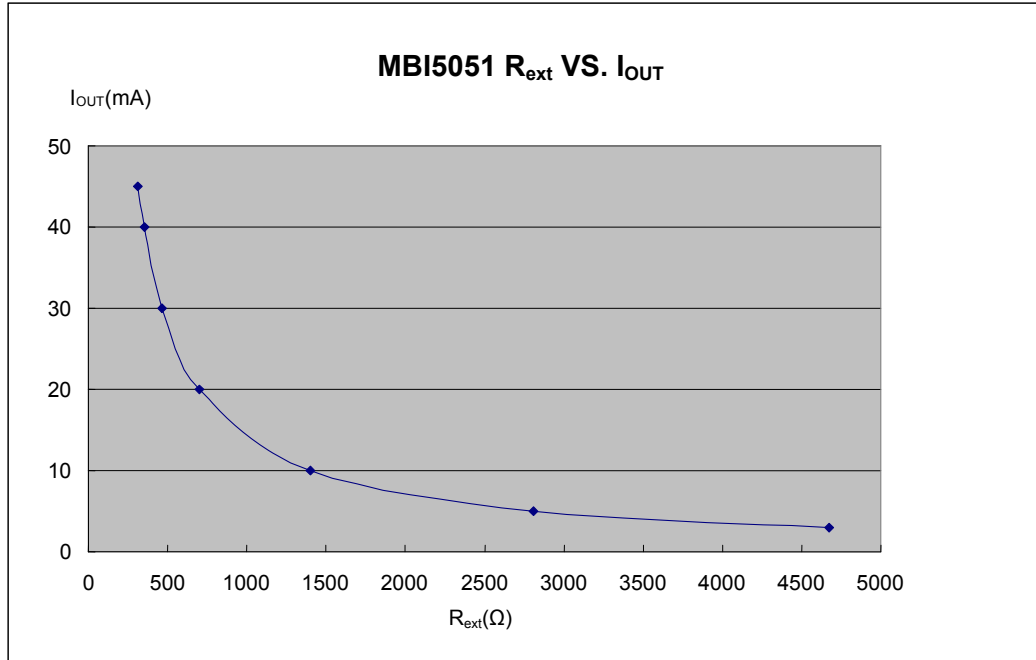

Figure 4

MBI5051 16-Channel PWM Constant Current LED Driver for 1:8 Time-multiplexing Applications

Setting Output Current

The output current (I_{OUT}) is set by an external resistor, R_{ext} . The default relationship between I_{OUT} and R_{ext} is shown in the following figure.



Also, the output current can be calculated from the equation:

$$V_{R-EXT}=0.61\text{Volt} ; I_{OUT}=V_{R-EXT}/R_{ext} \times 25.0$$

Whereas R_{ext} is the resistance of the external resistor connected to R-EXT terminal and V_{R-EXT} is its voltage.

MBI5051 16-Channel PWM Constant Current LED Driver for 1:8 Time-multiplexing Applications

Staggered Delay of Output

MBI5051 has a built-in staggered circuit to perform delay mechanism. Among output ports exist a incremental 5ns delay time among $\overline{OUT2n}$ and $\overline{OUT2n+1}$, by which the output ports will be divided to four groups at a different time so that the instant current from the power line will be lowered.

Package Power Dissipation (PD)

The maximum allowable package power dissipation is determined as $P_D(max)=(T_j-T_a)/R_{th(j-a)}$. When 16 output channels are turned on simultaneously, the actual package power dissipation is

$P_D(act)=(I_{DD} \times V_{DD})+(I_{OUT} \times Duty \times V_{DS} \times 16)$. Therefore, to keep $P_D(act) \leq P_D(max)$, the allowable maximum output current as a function of duty cycle is:

$$I_{OUT} = \{[(T_j - T_a) / R_{th(j-a)}] - (I_{DD} \times V_{DD})\} / V_{DS} / Duty / 16, \text{ where } T_j = 150^\circ\text{C}.$$

Please see the follow table for P_D and $R_{th(j-a)}$ for different packages:

Device Type	$R_{th(j-a)}$ ($^\circ\text{C}/\text{W}$)	P_D (W)
GF	66.69	1.87
GP	69.5	1.79

The maximum power dissipation, $P_D(max)=(T_j-T_a)/R_{th(j-a)}$, decreases as the ambient temperature increases.

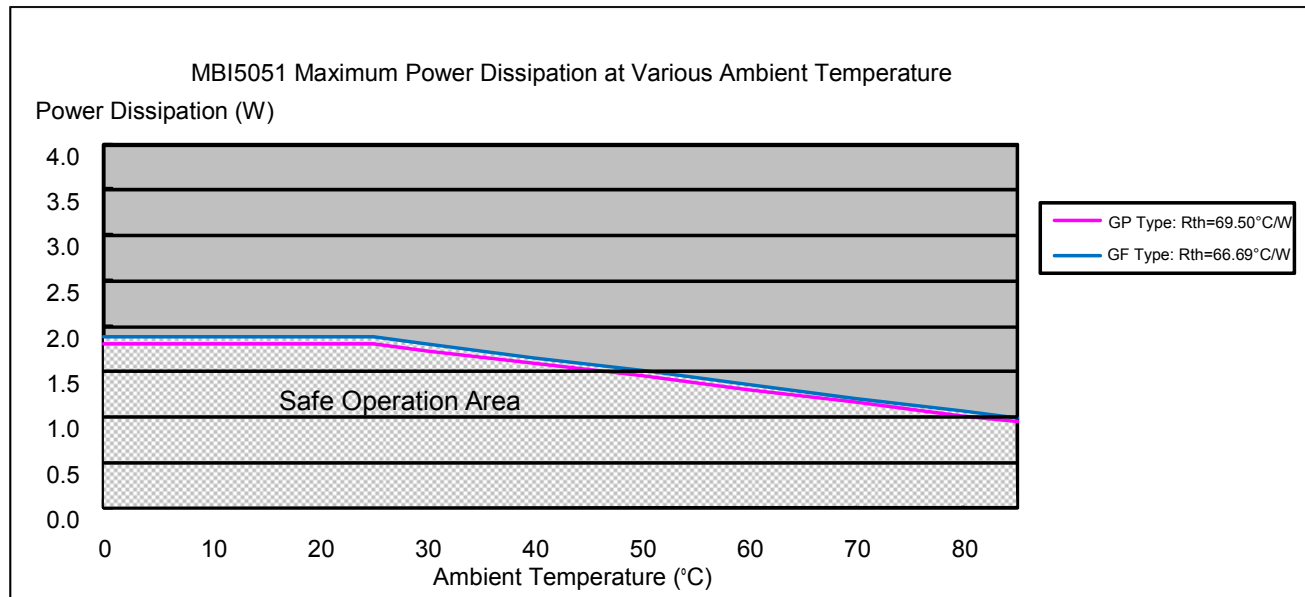

MBI5051 16-Channel PWM Constant Current LED Driver for 1:8 Time-multiplexing Applications

LED Supply Voltage (V_{LED})

MBI5051 is designed to operate with V_{DS} ranging from 0.4V to 1.0V (depending on $I_{OUT}=2\sim 45mA$) considering the package power dissipating limits. V_{DS} may be higher enough to make $P_{D(act)} > P_{D(max)}$ when $V_{LED}=5V$ and $V_{DS}=V_{LED}-V_F$, in which V_{LED} is the load supply voltage. In this case, it is recommended to use the lowest possible supply voltage or to set an external voltage reducer, V_{DROP} .

A voltage reducer lets $V_{DS}=(V_{LED}-V_F)-V_{DROP}$.

Resistors or Zener diode can be used in the applications as shown in the following figures.

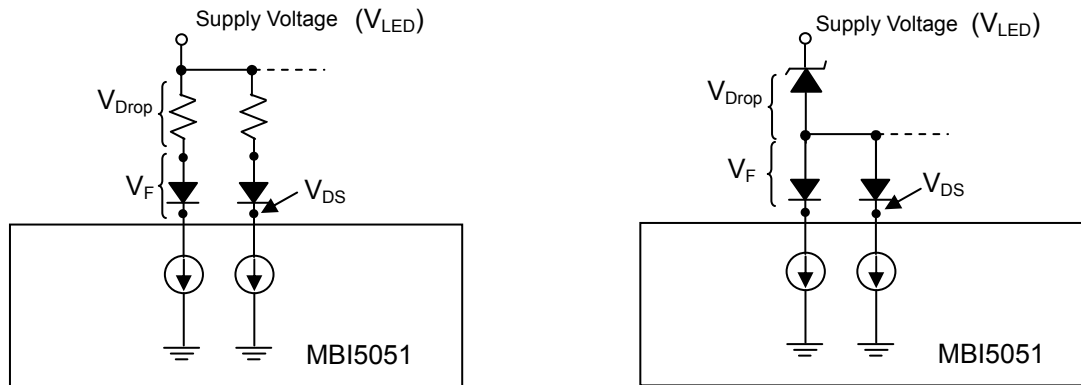

Figure 5

Switching Noise Reduction

LED drivers are frequently used in switch-mode applications which always behave with switching noise due to the parasitic inductance on PCB. To eliminate switching noise, refer to "Application Note for 8-bit and 16-bit LED Drivers- Overshoot".

MBI5051 16-Channel PWM Constant Current LED Driver for 1:8 Time-multiplexing Applications

Soldering Process of "Pb-free & Green" Package Plating*

Macroblock has defined "Pb-free & Green" to mean semiconductor products that are compatible with the current RoHS requirements and selected 100% pure tin (Sn) to provide forward and backward compatibility with both the current industry-standard SnPb-based soldering processes and higher-temperature Pb-free processes. Pure tin is widely accepted by customers and suppliers of electronic devices in Europe, Asia and the US as the lead-free surface finish of choice to replace tin-lead. Also, it adopts tin/lead (SnPb) solder paste, and please refer to the JEDEC J-STD-020C for the temperature of solder bath. However, in the whole Pb-free soldering processes and materials, 100% pure tin (Sn) will all require from 245 °C to 260 °C for proper soldering on boards, referring to JEDEC J-STD-020C as shown below.

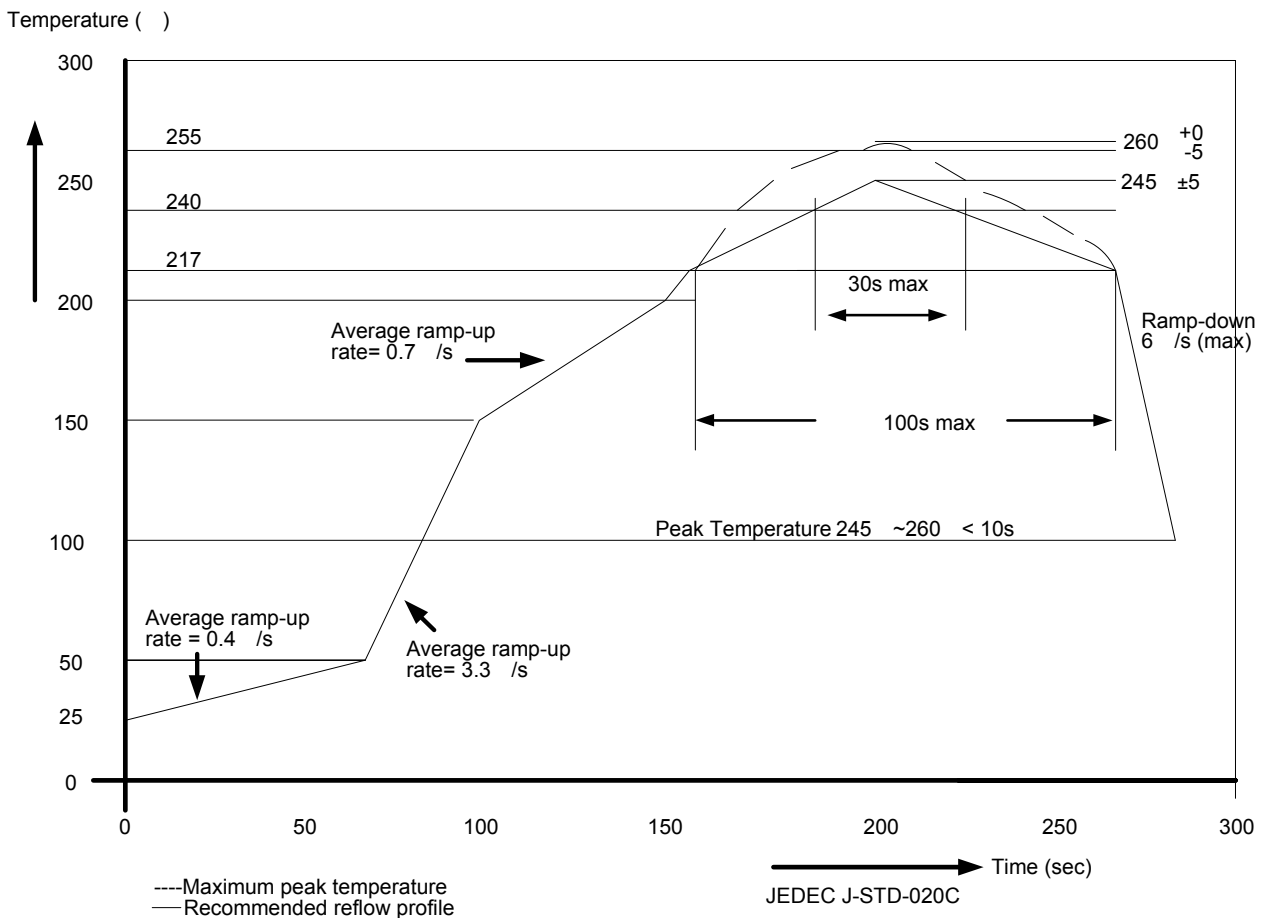

Package Thickness	Volume mm ³ <350	Volume mm ³ 350-2000	Volume mm ³ 2000
<1.6mm	260 +0 °C	260 +0 °C	260 +0 °C
1.6mm – 2.5mm	260 +0 °C	250 +0 °C	245 +0 °C
2.5mm	250 +0 °C	245 +0 °C	245 +0 °C

*Note: For details, please refer to Macroblock's "Policy on Pb-free & Green Package".

MBI5051 16-Channel PWM Constant Current LED Driver for 1:8 Time-multiplexing Applications

Package Outline

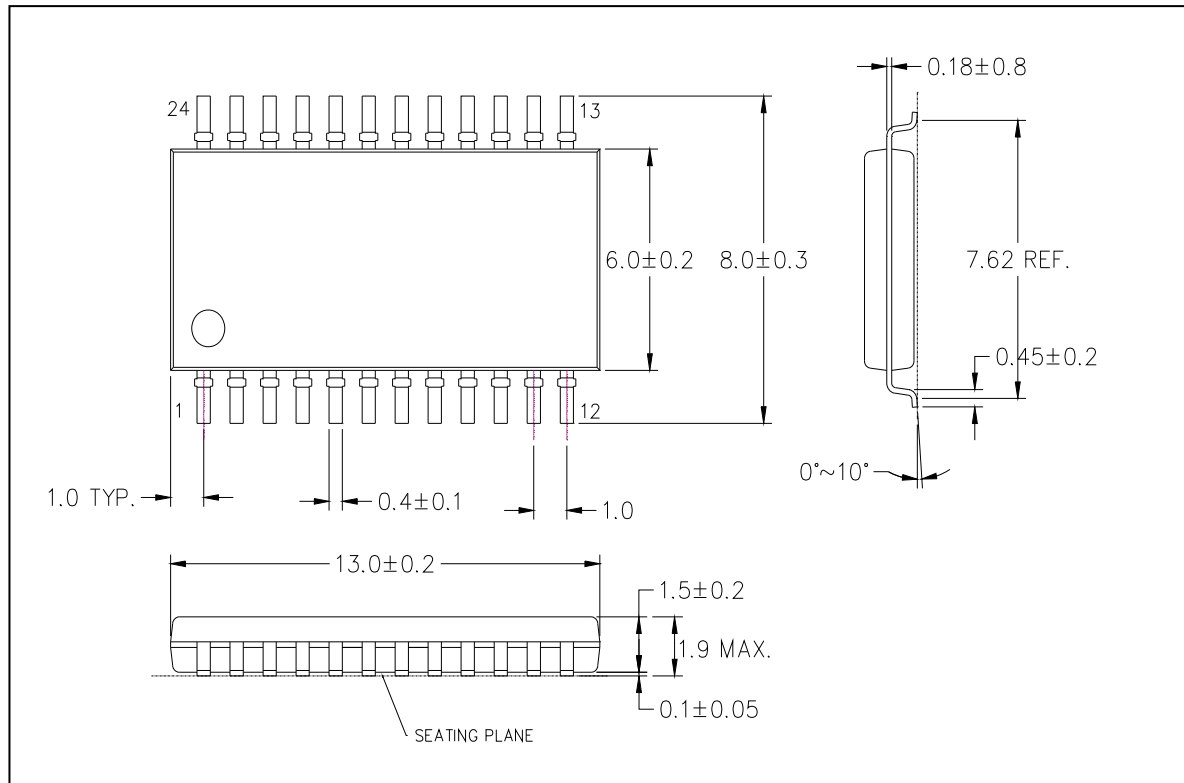

MBI5051 GF Outline Drawing

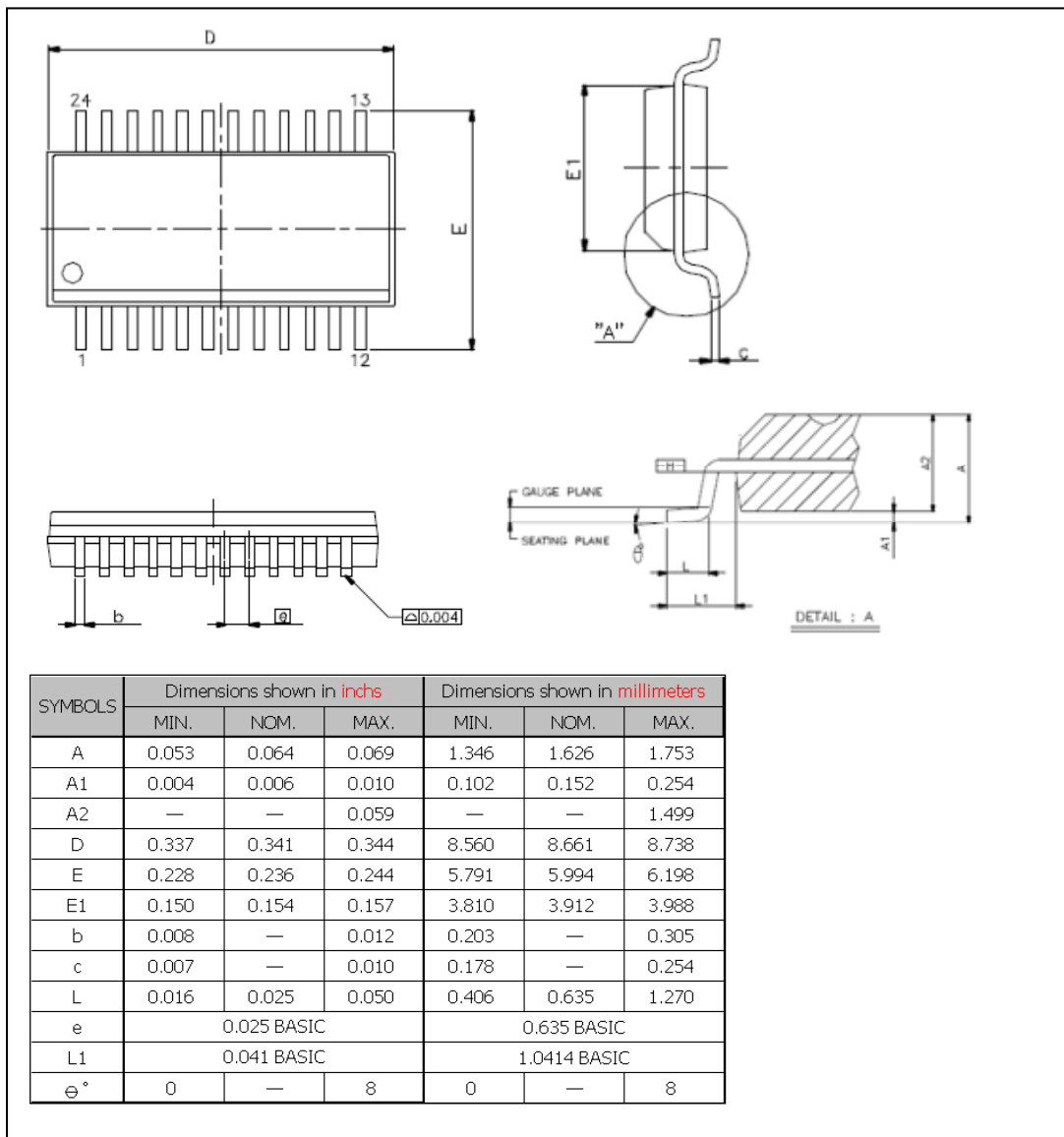
MBI5051**16-Channel PWM Constant Current LED Driver
for 1:8 Time-multiplexing Applications**

MBI5051 GP Outline Drawing

Note: The unit for the outline drawing is mm.

MBI5051 16-Channel PWM Constant Current LED Driver for 1:8 Time-multiplexing Applications

Product Top Mark Information

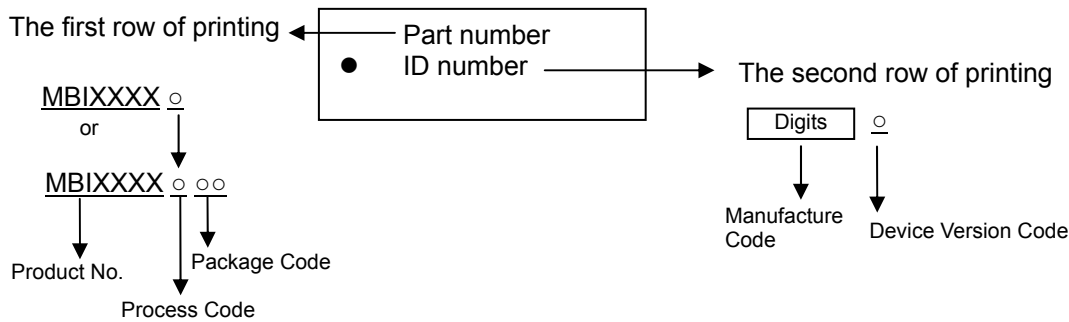

Product Revision History

Datasheet version	Device Version Code
V1.00	A
V1.01	A
V1.02	A

Product Ordering Information

Product Ordering Number*	"Pb-free & Green" Package Type	Weight (g)
MBI5051GF-A	SOP24L-236-1.00	0.28
MBI5051GP-A	SSOP24L-150-0.64	0.11

*Please place your order with the "**product ordering number**" information on your purchase order (PO).

MBI5051

16-Channel PWM Constant Current LED Driver for 1:8 Time-multiplexing Applications

Disclaimer

Macroblock reserves the right to make changes, corrections, modifications, and improvements to their products and documents or discontinue any product or service. Customers are advised to consult their sales representative for the latest product information before ordering. All products are sold subject to the terms and conditions supplied at the time of order acknowledgement, including those pertaining to warranty, patent infringement, and limitation of liability. Macroblock's products are not designed to be used as components in device intended to support or sustain life or in military applications. Use of Macroblock's products in components intended for surgical implant into the body, or other applications in which failure of Macroblock's products could create a situation where personal death or injury may occur, is not authorized without the express written approval of the Managing Director of Macroblock. Macroblock will not be held liable for any damages or claims resulting from the use of its products in medical and military applications.

Related technologies applied to the product are protected by patents. All text, images, logos and information contained on this document is the intellectual property of Macroblock. Unauthorized reproduction, duplication, extraction, use or disclosure of the above mentioned intellectual property will be deemed as infringement.