

Superior Efficacy and Lumen output with Small Form Factor

## Z Power LED – Z5-P1

**SZ5-P1-WX-XX (Cool, Neutral, Warm)**

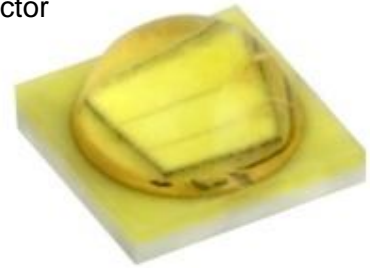

## Product Brief

### Description

- The Z-Power series is designed for high flux output applications with high current operation capability.
- It incorporates state of the art SMD design and low thermal resistant material.
- The Z Power LED is ideal light sources for directional lighting applications such as Spot Lights, various outdoor applications, automotive lightings and high performance torches .

### Features and Benefits

- High Lumen Output and Efficacy
- Designed for high current operation
- Low Thermal Resistance
- Wide CCT range 2600~7000K
- High Color Quality
- ANSI compliant Binning
- MacAdam 3 Step for Warm White

### Key Applications

- Indoor lighting
- Outdoor lighting
- Automotive
- Architectural lighting
- Industrial lighting (High/Low bay)
- Portable Torch
- Home appliance

**Table 1. Product Selection Table**

Part Number	CCT			CRI	
	Color	Min.	Typ.	Max.	Min
SZ5-P1-W0-00	Cool White	4700K	5300K	7000K	70
SZ5-P1-WN-00	Neutral White	3700K	4000K	4700K	70
SZ5-P1-WN-C8	Neutral White	3700K	4000K	4700K	80
SZ5-P1-WW-C8	Warm White	2600K	3000K	3700K	80

---

# Table of Contents

## Index

- Product Brief
- Table of Contents
- Performance Characteristics
- Color Bin Structure
- Mechanical Dimensions
- Packaging Information
- Product Nomenclature (Labeling Information)
- Recommended Solder Pad
- Reflow Soldering Characteristics
- Handling of Silicone Resin for LEDs
- Precaution For Use
- Company Information

## Performance Characteristics

**Table 2. Electro Optical Characteristics,  $T_j = 25^\circ\text{C}$ , RH30%**

Part Number	CCT (K) <sup>[1]</sup>	Typical Luminous Flux <sup>[2]</sup> $\Phi_v$ <sup>[3]</sup> (lm)			Typical Forward Voltage ( $V_F$ ) <sup>[4]</sup>			CRI <sup>[5]</sup> , $R_a$	Viewing Angle (degrees) $2\theta_{1/2}$
	Typ.	350mA	700mA*	1.0A*	350mA	700mA*	1.0A*	Min.	Typ.
SZ5-P1-W0-00	5300	148	260	338	3.05	3.26	3.39	70	118
SZ5-P1-WN-00	4000	143	251	327	3.05	3.26	3.39	70	118
SZ5-P1-WN-C8	4000	128	225	292	3.05	3.26	3.39	80	118
SZ5-P1-WW-C8	3000	115	202	263	3.05	3.26	3.39	80	118

**Table 3. Electro Optical Characteristics,  $T_j = 85^\circ\text{C}$** 

Part Number	CCT (K) <sup>[1]</sup>	Typical Luminous Flux <sup>[2]</sup> $\Phi_v$ <sup>[3]</sup> (lm)			Typical Forward Voltage ( $V_F$ ) <sup>[4]</sup>		
	Typ.	350mA	700mA*	1.0A*	350mA	700mA*	1.0A*
SZ5-P1-W0-00	5300	134	235	304	2.90	3.11	3.23
SZ5-P1-WN-00	4000	129	226	294	2.90	3.11	3.23
SZ5-P1-WN-C8	4000	115	202	263	2.90	3.11	3.23
SZ5-P1-WW-C8	3000	104	182	236	2.90	3.11	3.23

**Notes :**

- (1) Correlated Color Temperature is derived from the CIE 1931 Chromaticity diagram. Color coordinate :  $\pm 0.005$ , CCT  $\pm 5\%$  tolerance.
- (2) Seoul Semiconductor maintains a tolerance of  $\pm 7\%$  on flux and power measurements.
- (3)  $\Phi_v$  is the total luminous flux output as measured with an integrating sphere.
- (4) Tolerance is  $\pm 0.06\text{V}$  on forward voltage measurements.
- (5) Tolerance is  $\pm 2.0$  on CRI measurements.

\* No values are provided by real measurement. Only for reference purpose.

## Performance Characteristics

**Table 4. Absolute Maximum Ratings,  $T_j = 25^\circ\text{C}$** 

Parameter	Symbol	Value			Unit
		Min.	Typ.	Max.	
Forward Current <sup>[1]</sup>	$I_F$	-	-	1.0	A
Peak Pulsed Forward Current <sup>[2]</sup>	$I_F$			1.6	A
Reverse Voltage	$V_R$	-	-	5	V
Power Dissipation	$P_d$	-	-	3.39	W
Junction Temperature	$T_j$	-	-	150	$^\circ\text{C}$
Operating Temperature	$T_{opr}$	- 40	-	125	$^\circ\text{C}$
Storage Temperature	$T_{stg}$	- 40	-	125	$^\circ\text{C}$
Thermal resistance (J to S) <sup>[3]</sup>	$R\theta_{J-S}$	-	5.5	-	K/W
ESD Sensitivity(HBM) <sup>[4]</sup>		Class 3A JESD22-A114-E			

**Notes :**

- (1) At Junction Temperature  $25^\circ\text{C}$  condition.
- (2) Pulse width  $\leq 10\text{ms}$ , duty cycle  $\leq 10\%$  condition.
- (3)  $R\theta_{J-S}$  is tested at 350mA.
- (4) The zener diode is included to protect the product from ESD.

## Relative Spectral Distribution

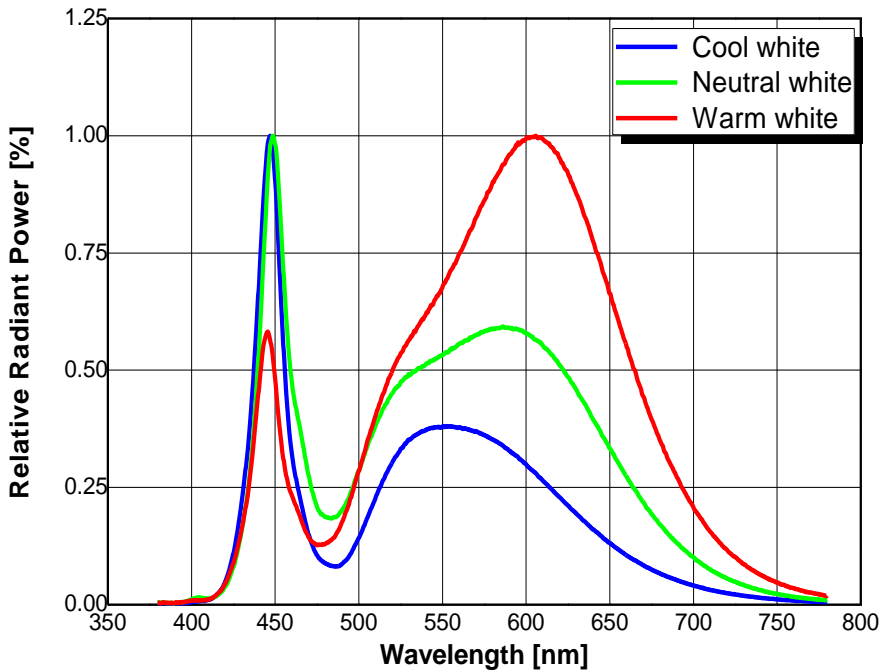
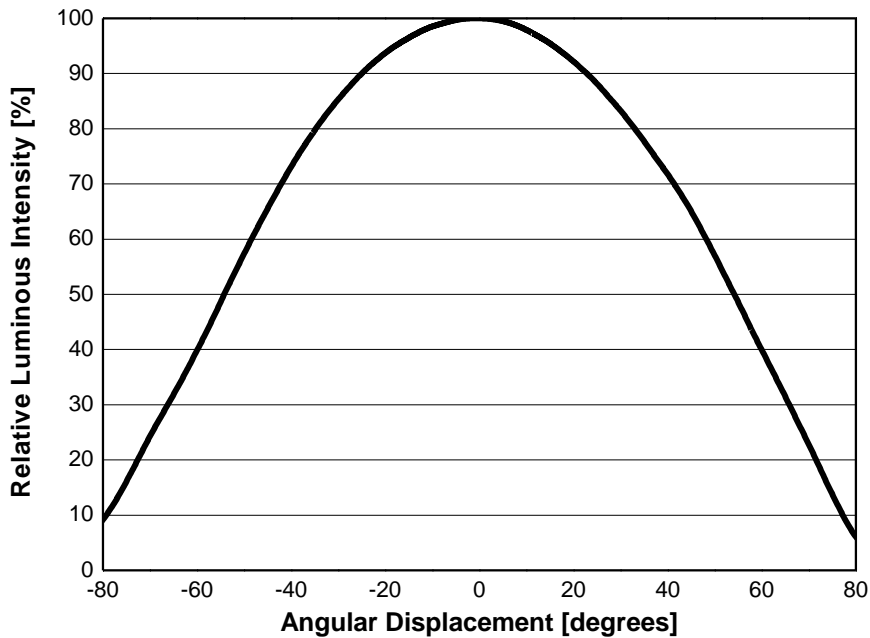
**Fig 1. Color Spectrum ( $T_j = 25^\circ\text{C}$ )**

**Fig 2. Typical Spatial Distribution**

## Forward Current Characteristics

Fig 3. Forward Voltage vs. Forward Current ( $T_j = 25^\circ\text{C}$ )

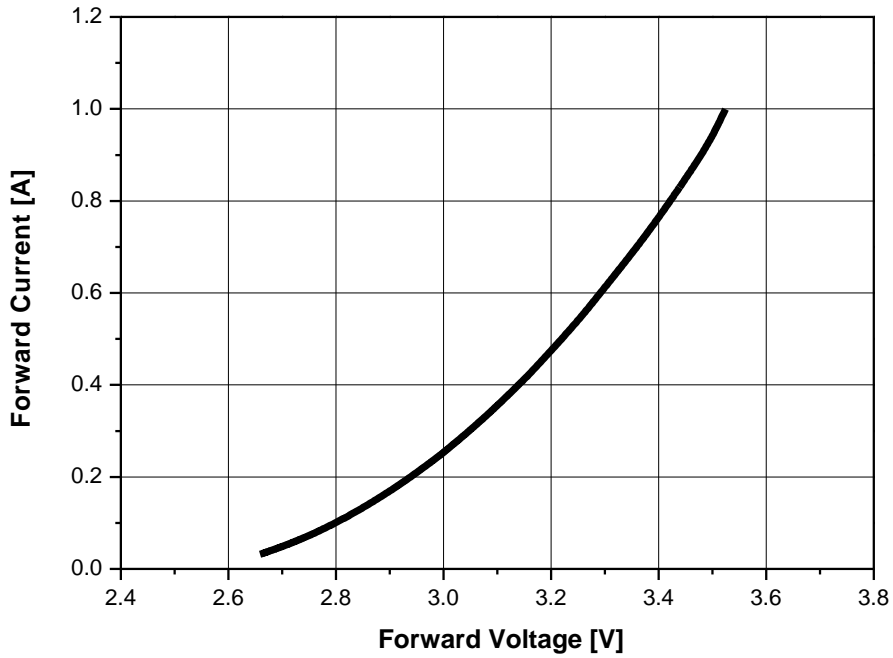
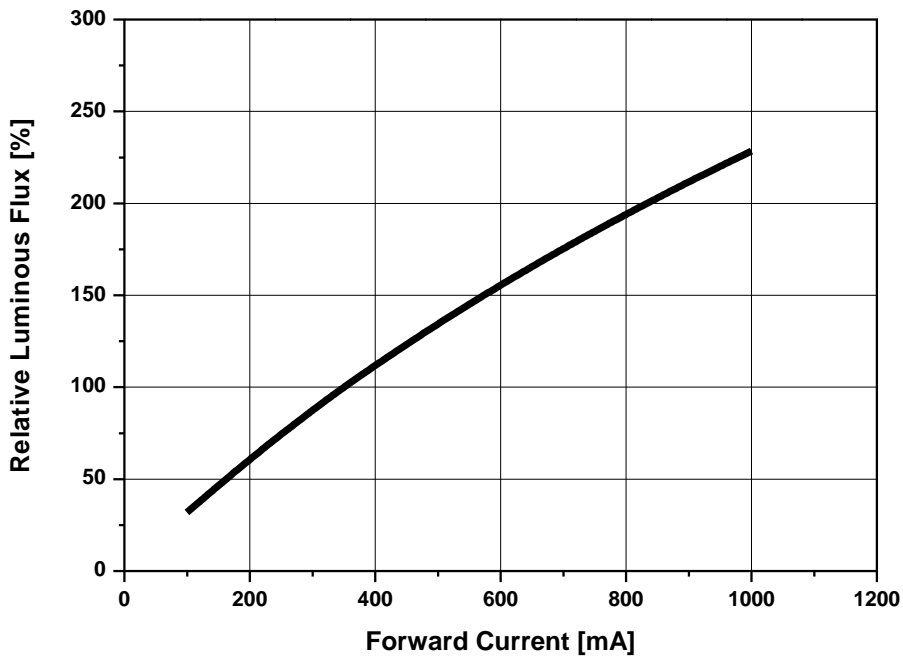
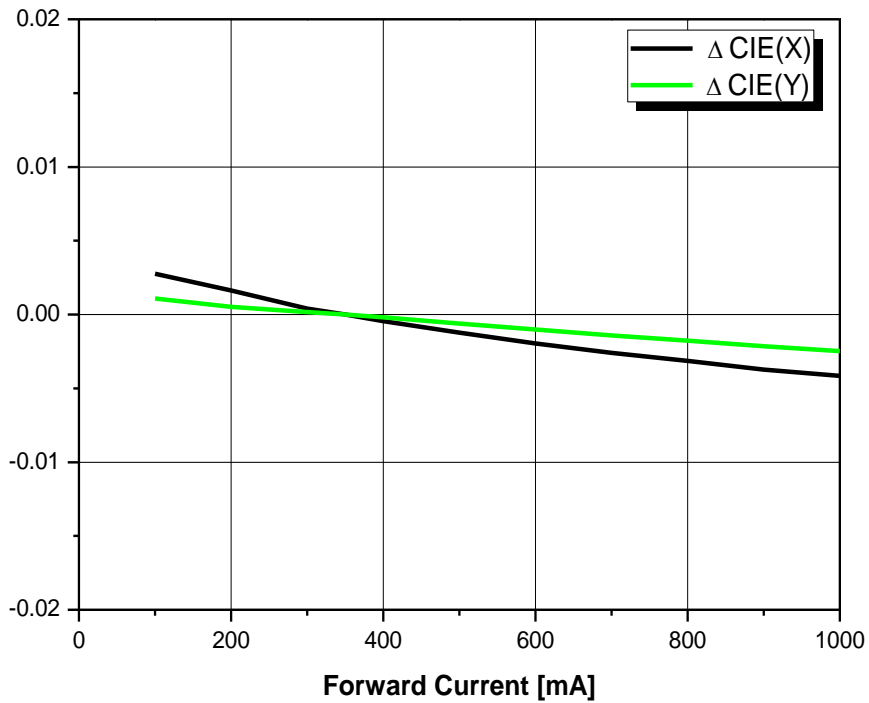

Fig 4. Forward Current vs. Relative Luminous Flux ( $T_j = 25^\circ\text{C}$ )



## Forward Current Characteristics

Fig 5. Forward Current vs. CIE X, Y Shift,  $T_j = 25^\circ\text{C}$

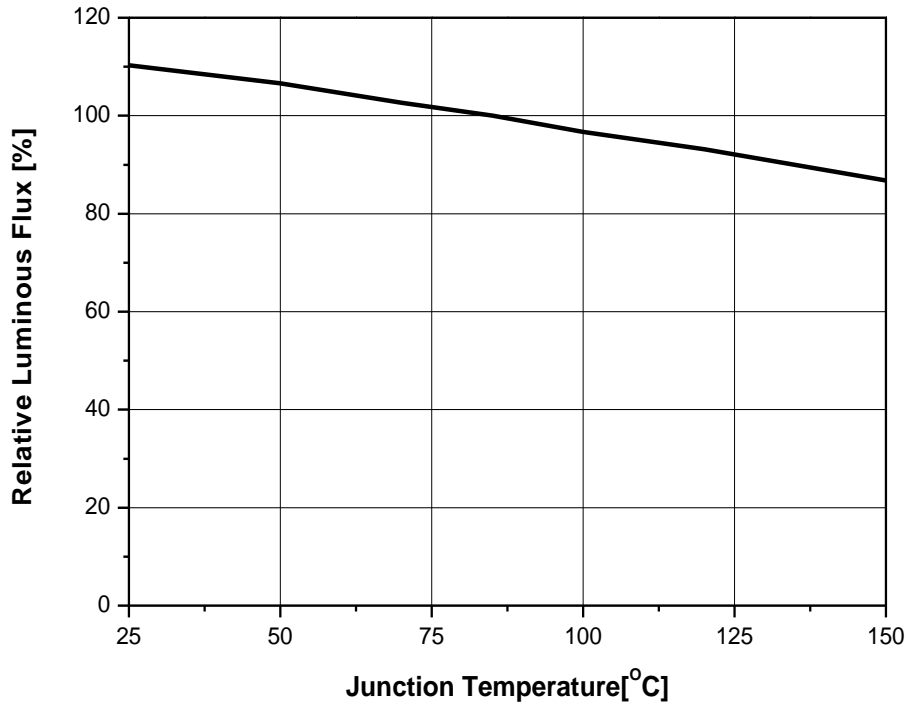
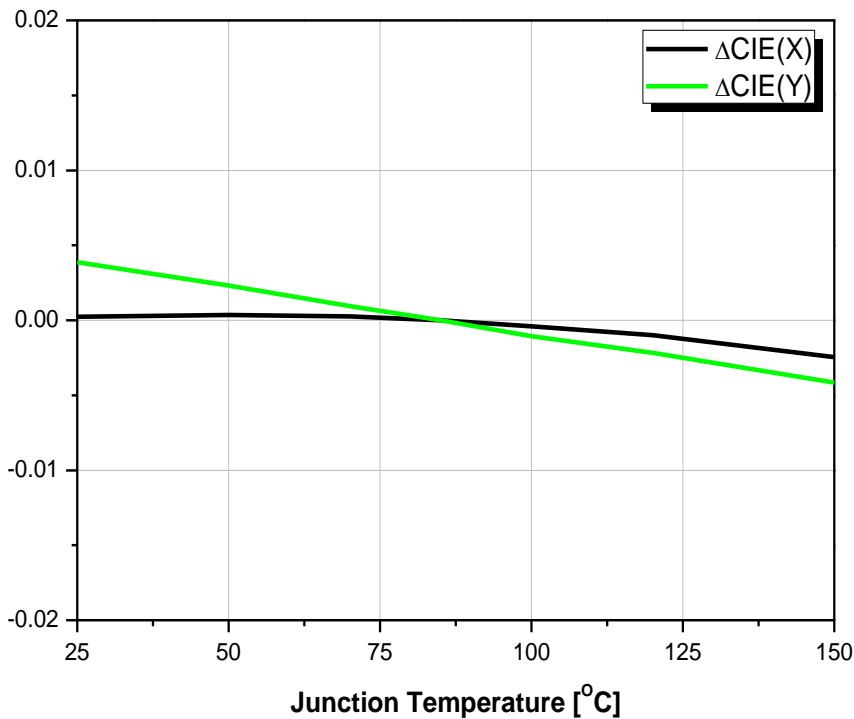

## Junction Temperature Characteristics

**Fig 6. Relative Light Output vs. Junction Temperature,  $I_F = 350\text{mA}$** 

**Fig 7. Junction Temp. vs. CIE X, Y Shift,  $I_F = 350\text{mA}$** 

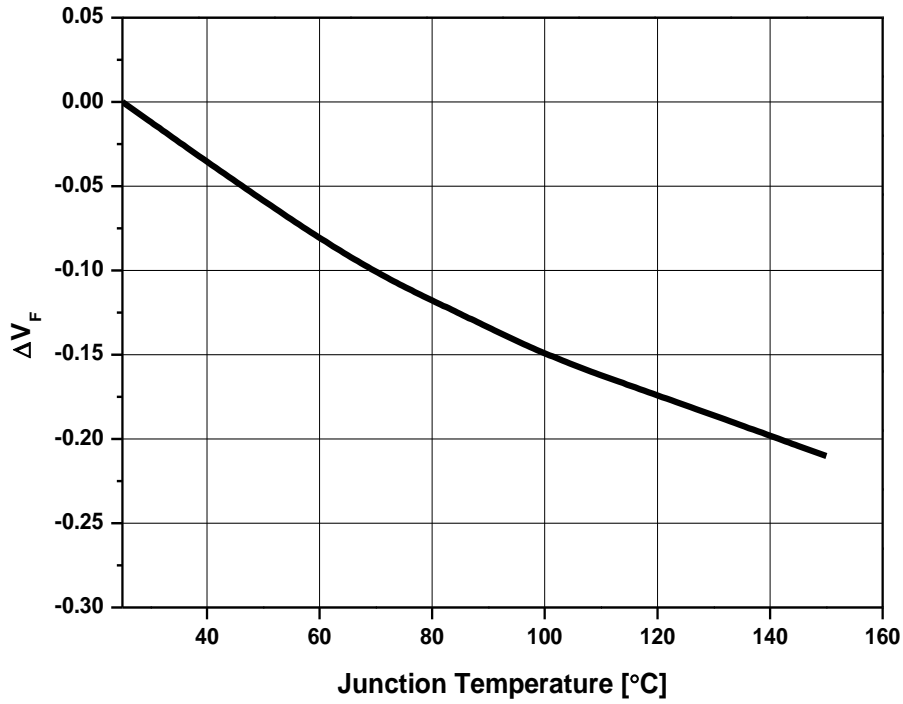

## Junction Temperature Characteristics

**Fig 8. Relative Forward vs. Junction Temperature,  $I_F = 350\text{mA}$**



## Ambient Temperature Characteristics

Fig 9. Maximum Forward Current vs. Ambient Temperature,  $T_j(\text{max.}) = 150^\circ\text{C}$ ,  $I_F = 1.0\text{A}$

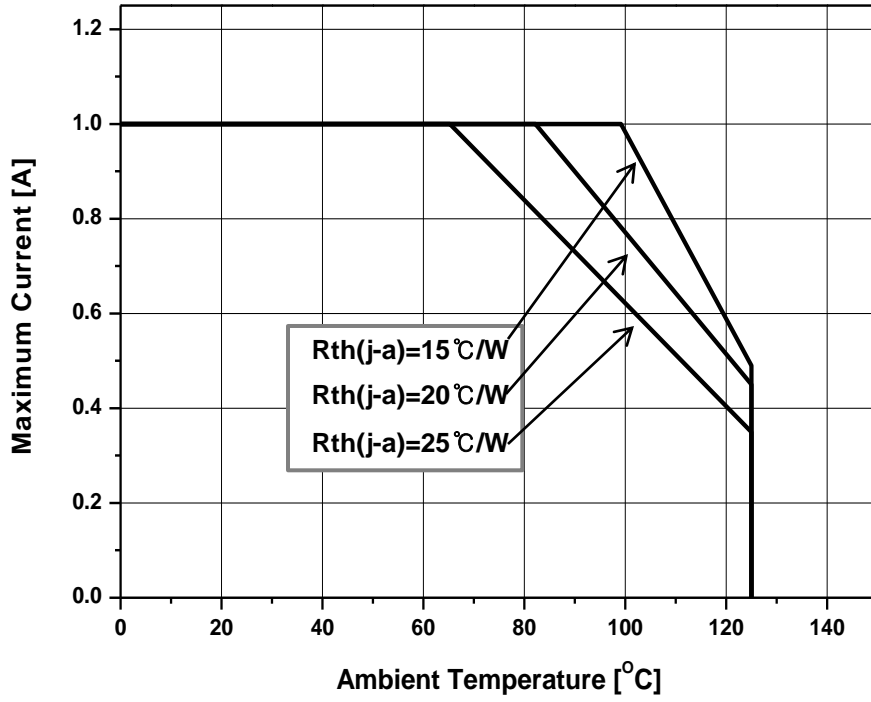

## Color Bin Structure

**Table 5. Bin Code description (@ $I_F=350\text{mA}$ ,  $T_J=25^\circ\text{C}$ )**

Part Number	Luminous Flux (lm)			Color Chromaticity Coordinate	Typical Forward Voltage ( $V_F$ )		
	Bin Code	Min.	Max.		Bin Code	Min.	Max.
SZ5-P1-W0-00	V1	118.5	130	Refer to page.12	G	2.75	3.00
	V2	130	140		H	3.00	3.25
	V3	140	150		I	3.25	3.50
	W1	150	160				
SZ5-P1-WN-00	V1	118.5	130	Refer to page.13	G	2.75	3.00
	V2	130	140		H	3.00	3.25
	V3	140	150		I	3.25	3.50
	W1	150	160				
SZ5-P1-WN-C8	U3	109	118.5	Refer to page.13	G	2.75	3.00
	V1	118.5	130		H	3.00	3.25
	V2	130	140		I	3.25	3.50
	V3	140	150				
SZ5-P1-WW-C8	U2	100	109	Refer to page.14	G	2.75	3.00
	U3	109	118.5		H	3.00	3.25
	V1	118.5	130		I	3.25	3.50
	V2	130	140				

## Color Bin Structure

**Table 6. Flux Bin Code description (@T<sub>j</sub>=85°C)**

Luminous Flux (lm)				
Bin Code	350mA*		700mA*	
	Min.	Max.	Min.	Max.
U2	90	98	159	173
U3	98	107	173	188
V1	107	118	188	207
V2	118	127	207	222
V3	127	136	222	238
W1	136	145	238	254

**Table 7. VF Bin Code description (@T<sub>j</sub>=85°C)**

Forward Voltage (V <sub>F</sub> )				
Bin Code	350mA*		700mA*	
	Min.	Max.	Min.	Max.
G	2.61	2.85	2.79	3.05
H	2.85	3.09	3.05	3.30
I	3.09	3.32	3.30	3.55

\* No values are provided by real measurement. Only for reference purpose.

## Color Bin Structure

CIE Chromaticity Diagram (Cool white),  $T_j=25^\circ\text{C}$ ,  $I_f = 350\text{mA}$

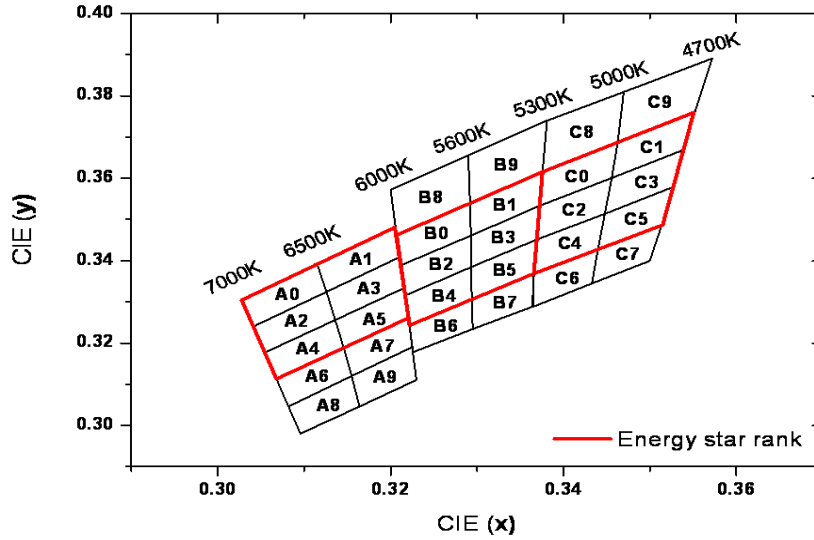

<b>A0</b>		<b>A1</b>		<b>A2</b>		<b>A3</b>		<b>A4</b>	
CIE x	CIE y	CIE x	CIE y	CIE x	CIE y	CIE x	CIE y	CIE x	CIE y
0.3028	0.3304	0.3115	0.3393	0.3041	0.3240	0.3126	0.3324	0.3055	0.3177
0.3041	0.3240	0.3126	0.3324	0.3055	0.3177	0.3136	0.3256	0.3068	0.3113
0.3126	0.3324	0.3210	0.3408	0.3136	0.3256	0.3216	0.3334	0.3146	0.3187
0.3115	0.3393	0.3205	0.3481	0.3126	0.3324	0.3210	0.3408	0.3136	0.3256
<b>A5</b>		<b>A6</b>		<b>A7</b>		<b>A8</b>		<b>A9</b>	
CIE x	CIE y	CIE x	CIE y	CIE x	CIE y	CIE x	CIE y	CIE x	CIE y
0.3136	0.3256	0.3068	0.3113	0.3146	0.3187	0.3082	0.3046	0.3155	0.3120
0.3146	0.3187	0.3082	0.3046	0.3155	0.3120	0.3096	0.2980	0.3164	0.3046
0.3221	0.3261	0.3155	0.3120	0.3225	0.3190	0.3164	0.3046	0.3230	0.3110
0.3216	0.3334	0.3146	0.3187	0.3221	0.3261	0.3155	0.3120	0.3225	0.3190
<b>B0</b>		<b>B1</b>		<b>B2</b>		<b>B3</b>		<b>B4</b>	
CIE x	CIE y	CIE x	CIE y	CIE x	CIE y	CIE x	CIE y	CIE x	CIE y
0.3207	0.3462	0.3292	0.3539	0.3212	0.3389	0.3293	0.3461	0.3217	0.3316
0.3212	0.3389	0.3293	0.3461	0.3217	0.3316	0.3293	0.3384	0.3222	0.3243
0.3293	0.3461	0.3373	0.3534	0.3293	0.3384	0.3369	0.3451	0.3294	0.3306
0.3292	0.3539	0.3376	0.3616	0.3293	0.3461	0.3373	0.3534	0.3293	0.3384
<b>B5</b>		<b>B6</b>		<b>B7</b>		<b>B8</b>		<b>B9</b>	
CIE x	CIE y	CIE x	CIE y	CIE x	CIE y	CIE x	CIE y	CIE x	CIE y
0.3293	0.3384	0.3222	0.3243	0.3294	0.3306	0.3200	0.3572	0.3290	0.3656
0.3294	0.3306	0.3226	0.3178	0.3295	0.3234	0.3207	0.3462	0.3292	0.3539
0.3366	0.3369	0.3295	0.3234	0.3364	0.3288	0.3292	0.3539	0.3376	0.3616
0.3369	0.3451	0.3294	0.3306	0.3366	0.3369	0.3290	0.3656	0.3381	0.3740
<b>C0</b>		<b>C1</b>		<b>C2</b>		<b>C3</b>		<b>C4</b>	
CIE x	CIE y	CIE x	CIE y	CIE x	CIE y	CIE x	CIE y	CIE x	CIE y
0.3376	0.3616	0.3463	0.3687	0.3373	0.3534	0.3456	0.3601	0.3369	0.3451
0.3373	0.3534	0.3456	0.3601	0.3369	0.3451	0.3448	0.3514	0.3366	0.3369
0.3456	0.3601	0.3539	0.3669	0.3448	0.3514	0.3526	0.3578	0.3440	0.3428
0.3463	0.3687	0.3552	0.3760	0.3456	0.3601	0.3539	0.3669	0.3448	0.3514
<b>C5</b>		<b>C6</b>		<b>C7</b>		<b>C8</b>		<b>C9</b>	
CIE x	CIE y	CIE x	CIE y	CIE x	CIE y	CIE x	CIE y	CIE x	CIE y
0.3448	0.3514	0.3366	0.3369	0.3440	0.3428	0.3381	0.3740	0.3470	0.3810
0.3440	0.3428	0.3364	0.3288	0.3433	0.3345	0.3376	0.3616	0.3463	0.3687
0.3514	0.3487	0.3433	0.3345	0.3500	0.3400	0.3463	0.3687	0.3552	0.3760
0.3526	0.3578	0.3440	0.3428	0.3514	0.3487	0.3470	0.3810	0.3572	0.3891

## Color Bin Structure

CIE Chromaticity Diagram (Neutral white),  $T_j=25^\circ\text{C}$ ,  $I_f = 350\text{mA}$

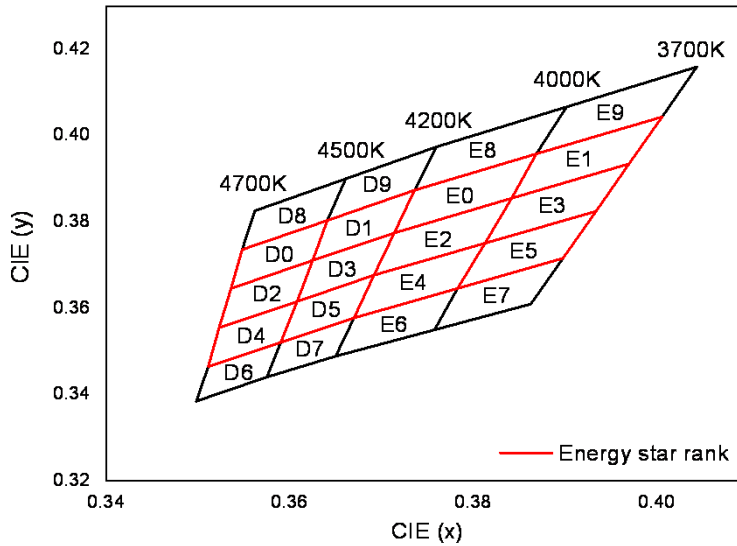

D0		D1		D2		D3		D4	
CIE x	CIE y	CIE x	CIE y	CIE x	CIE y	CIE x	CIE y	CIE x	CIE y
0.3548	0.3736	0.3641	0.3804	0.3536	0.3646	0.3625	0.3711	0.3524	0.3555
0.3536	0.3646	0.3625	0.3711	0.3524	0.3555	0.3608	0.3616	0.3512	0.3465
0.3625	0.3711	0.3714	0.3775	0.3608	0.3616	0.3692	0.3677	0.3590	0.3521
0.3641	0.3804	0.3736	0.3874	0.3625	0.3711	0.3714	0.3775	0.3608	0.3616
D5		D6		D7		D8		D9	
CIE x	CIE y	CIE x	CIE y	CIE x	CIE y	CIE x	CIE y	CIE x	CIE y
0.3608	0.3616	0.3512	0.3465	0.3590	0.3521	0.3562	0.3826	0.3661	0.3900
0.3590	0.3521	0.3497	0.3385	0.3575	0.3441	0.3548	0.3736	0.3641	0.3804
0.3670	0.3578	0.3575	0.3441	0.3650	0.3489	0.3641	0.3804	0.3736	0.3874
0.3692	0.3677	0.3590	0.3521	0.3670	0.3578	0.3661	0.3900	0.3760	0.3974
E0		E1		E2		E3		E4	
CIE x	CIE y	CIE x	CIE y	CIE x	CIE y	CIE x	CIE y	CIE x	CIE y
0.3736	0.3874	0.3869	0.3958	0.3714	0.3775	0.3842	0.3855	0.3692	0.3677
0.3714	0.3775	0.3842	0.3855	0.3692	0.3677	0.3813	0.3751	0.3670	0.3578
0.3842	0.3855	0.3970	0.3935	0.3813	0.3751	0.3934	0.3825	0.3783	0.3646
0.3869	0.3958	0.4006	0.4044	0.3842	0.3855	0.3970	0.3935	0.3813	0.3751
E5		E6		E7		E8		E9	
CIE x	CIE y	CIE x	CIE y	CIE x	CIE y	CIE x	CIE y	CIE x	CIE y
0.3813	0.3751	0.3670	0.3578	0.3783	0.3646	0.3760	0.3974	0.3902	0.4067
0.3783	0.3646	0.3650	0.3489	0.3758	0.3550	0.3736	0.3874	0.3869	0.3958
0.3898	0.3716	0.3758	0.3550	0.3863	0.3610	0.3869	0.3958	0.4006	0.4044
0.3934	0.3825	0.3783	0.3646	0.3898	0.3716	0.3902	0.4067	0.4044	0.4160

## Color Bin Structure

CIE Chromaticity Diagram (Warm white),  $T_j=25^\circ\text{C}$ ,  $I_F = 350\text{mA}$

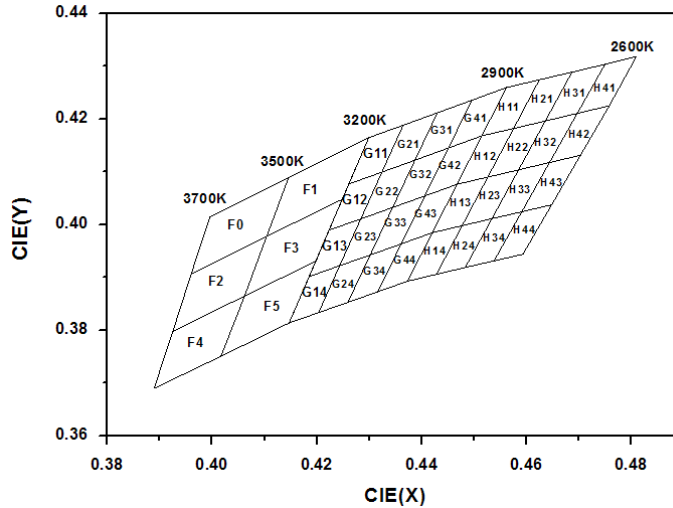

F0		F1		F2		F3		F4	
CIE x	CIE y	CIE x	CIE y	CIE x	CIE y	CIE x	CIE y	CIE x	CIE y
0.3996	0.4015	0.4146	0.4089	0.396	0.3907	0.4104	0.3978	0.3925	0.3798
0.396	0.3907	0.4104	0.3978	0.3925	0.3798	0.4062	0.3865	0.3889	0.369
0.4104	0.3978	0.4248	0.4048	0.4062	0.3865	0.4198	0.3931	0.4017	0.3751
0.4146	0.4089	0.4299	0.4165	0.4104	0.3978	0.4248	0.4048	0.4062	0.3865
F5		G11		G12		G13		G14	
CIE x	CIE y	CIE x	CIE y	CIE x	CIE y	CIE x	CIE y	CIE x	CIE y
0.4062	0.3865	0.4299	0.4165	0.4261	0.4077	0.4223	0.3990	0.4185	0.3902
0.4017	0.3751	0.4261	0.4077	0.4223	0.3990	0.4185	0.3902	0.4147	0.3814
0.4147	0.3814	0.4324	0.4100	0.4284	0.4011	0.4243	0.3922	0.4203	0.3834
0.4198	0.3931	0.4365	0.4189	0.4324	0.4100	0.4284	0.4011	0.4243	0.3922
G21		G22		G23		G24		G31	
CIE x	CIE y	CIE x	CIE y	CIE x	CIE y	CIE x	CIE y	CIE x	CIE y
0.4365	0.4189	0.4324	0.4100	0.4284	0.4011	0.4243	0.3922	0.4430	0.4212
0.4324	0.4100	0.4284	0.4011	0.4243	0.3922	0.4203	0.3834	0.4387	0.4122
0.4387	0.4122	0.4345	0.4033	0.4302	0.3943	0.4259	0.3853	0.4451	0.4145
0.4430	0.4212	0.4387	0.4122	0.4345	0.4033	0.4302	0.3943	0.4496	0.4236
G32		G33		G34		G41		G42	
CIE x	CIE y	CIE x	CIE y	CIE x	CIE y	CIE x	CIE y	CIE x	CIE y
0.4387	0.4122	0.4345	0.4033	0.4302	0.3943	0.4496	0.4236	0.4451	0.4145
0.4345	0.4033	0.4302	0.3943	0.4259	0.3853	0.4451	0.4145	0.4406	0.4055
0.4406	0.4055	0.4361	0.3964	0.4316	0.3873	0.4515	0.4168	0.4468	0.4077
0.4451	0.4145	0.4406	0.4055	0.4361	0.3964	0.4562	0.4260	0.4515	0.4168
G43		G44		H11		H12		H13	
CIE x	CIE y	CIE x	CIE y	CIE x	CIE y	CIE x	CIE y	CIE x	CIE y
0.4406	0.4055	0.4361	0.3964	0.4625	0.4275	0.4575	0.4182	0.4526	0.4090
0.4361	0.3964	0.4316	0.3873	0.4575	0.4182	0.4526	0.4090	0.4477	0.3998
0.4420	0.3985	0.4373	0.3893	0.4515	0.4168	0.4468	0.4077	0.4420	0.3985
0.4468	0.4077	0.4420	0.3985	0.4562	0.4260	0.4515	0.4168	0.4468	0.4077
H14		H21		H22		H23		H24	
CIE x	CIE y	CIE x	CIE y	CIE x	CIE y	CIE x	CIE y	CIE x	CIE y
0.4477	0.3998	0.4687	0.4289	0.4636	0.4197	0.4585	0.4104	0.4534	0.4012
0.4428	0.3906	0.4636	0.4197	0.4585	0.4104	0.4534	0.4012	0.4483	0.3919
0.4373	0.3893	0.4575	0.4182	0.4526	0.4090	0.4477	0.3998	0.4428	0.3906
0.4420	0.3985	0.4625	0.4275	0.4575	0.4182	0.4526	0.4090	0.4477	0.3998
H31		H32		H33		H34		H41	
CIE x	CIE y	CIE x	CIE y	CIE x	CIE y	CIE x	CIE y	CIE x	CIE y
0.4750	0.4304	0.4697	0.4211	0.4644	0.4118	0.4591	0.4025	0.4810	0.4319
0.4697	0.4211	0.4644	0.4118	0.4591	0.4025	0.4538	0.3932	0.4758	0.4225
0.4636	0.4197	0.4585	0.4104	0.4534	0.4012	0.4483	0.3919	0.4697	0.4211
0.4687	0.4289	0.4636	0.4197	0.4585	0.4104	0.4534	0.4012	0.4750	0.4304
H42		H43		H44					
CIE x	CIE y	CIE x	CIE y	CIE x	CIE y				
0.4758	0.4225	0.4703	0.4132	0.4648	0.4038				
0.4703	0.4132	0.4648	0.4038	0.4593	0.3944				
0.4644	0.4118	0.4591	0.4025	0.4538	0.3932				
0.4697	0.4211	0.4644	0.4188	0.4591	0.4025				

## Mechanical Dimensions

### Top View

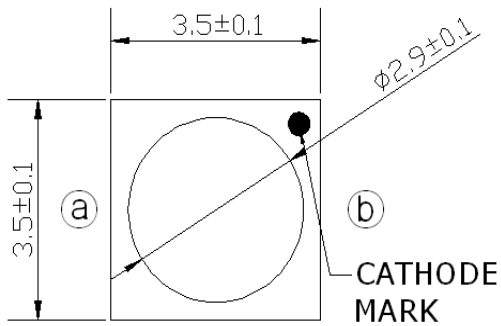

### Bottom View

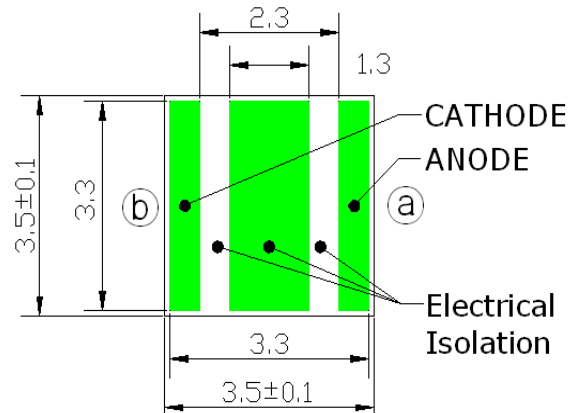

### Side View

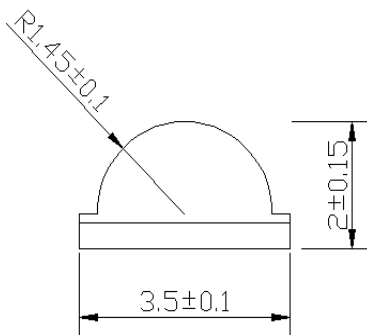

### Circuit

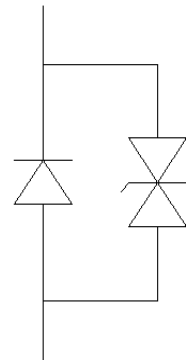

#### Notes :

- (1) All dimensions are in millimeters.
- (2) Scale : none
- (3) Undefined tolerance is  $\pm 0.1\text{mm}$



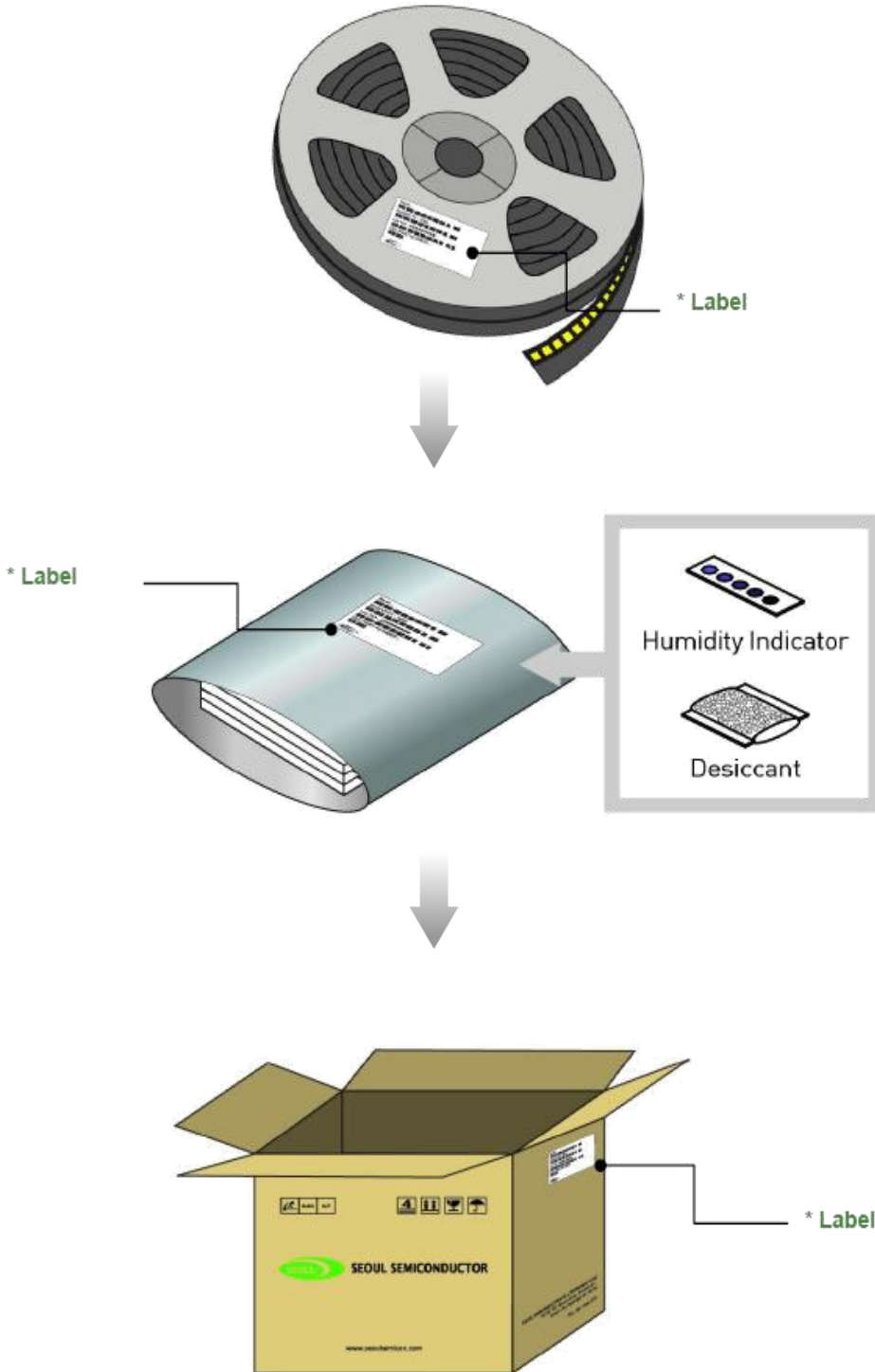

# Emitter Tape & Reel Packaging





## Product Nomenclature

**RANK : Z<sub>1</sub>Z<sub>1</sub>Z<sub>2</sub>Z<sub>2</sub>Z<sub>3</sub>**  

**QUANTITY : 1000**  

**LOT NUMBER : Y<sub>1</sub>Y<sub>1</sub>Y<sub>2</sub>Y<sub>3</sub>Y<sub>3</sub>Y<sub>4</sub>Y<sub>5</sub>Y<sub>5</sub>Y<sub>5</sub> - Y<sub>6</sub>Y<sub>6</sub>Y<sub>6</sub> - Y<sub>7</sub>Y<sub>7</sub>Y<sub>7</sub> - Y<sub>8</sub>Y<sub>8</sub>Y<sub>8</sub>Y<sub>8</sub>Y<sub>8</sub>**  

**SSC PART NUMBER : X<sub>1</sub>X<sub>2</sub>X<sub>3</sub>-X<sub>4</sub>X<sub>5</sub>-X<sub>6</sub>X<sub>7</sub>-X<sub>8</sub>X<sub>9</sub>**  



**Table 8. Part Numbering System : X<sub>1</sub>X<sub>2</sub>X<sub>3</sub> - X<sub>4</sub>X<sub>5</sub> - X<sub>6</sub>X<sub>7</sub> - X<sub>8</sub>X<sub>9</sub>**

Part Number Code	Description	Part Number	Value
X <sub>1</sub>	Company	S	
X <sub>2</sub>	Z-Power LED series number	Z	
X <sub>3</sub>	PKG series	5	
X <sub>4</sub>	PKG series	P	P series
X <sub>5</sub>	Revision number	1	New version
X <sub>6</sub> X <sub>7</sub>	Color Specification	W0	Pure white
		WN	Neutral white
		WW	Warm white
X <sub>8</sub> X <sub>9</sub>	Color Specification	C8	CRI (min.) 80
		C9	CRI (min.) 90
		00	The others

**Table 9. Lot Numbering System : Y<sub>1</sub>Y<sub>1</sub>Y<sub>2</sub>Y<sub>3</sub>Y<sub>3</sub>Y<sub>4</sub>Y<sub>5</sub>Y<sub>5</sub>Y<sub>5</sub> - Y<sub>6</sub>Y<sub>6</sub>Y<sub>6</sub> - Y<sub>7</sub>Y<sub>7</sub>Y<sub>7</sub> - Y<sub>8</sub>Y<sub>8</sub>Y<sub>8</sub>Y<sub>8</sub>Y<sub>8</sub>**

Lot Number Code	Description
Y <sub>1</sub>	Year
Y <sub>2</sub>	Month
Y <sub>3</sub>	Day
Y <sub>4</sub>	Production area
Y <sub>5</sub>	Mass order
Y <sub>6</sub>	Taping number
Y <sub>7</sub>	Reel number
Y <sub>8</sub>	Internal management number

 [1] Z<sub>1</sub>: Flux rank    Z<sub>2</sub>: Chromaticity    Z<sub>3</sub>: VF rank

## Recommended Solder Pad

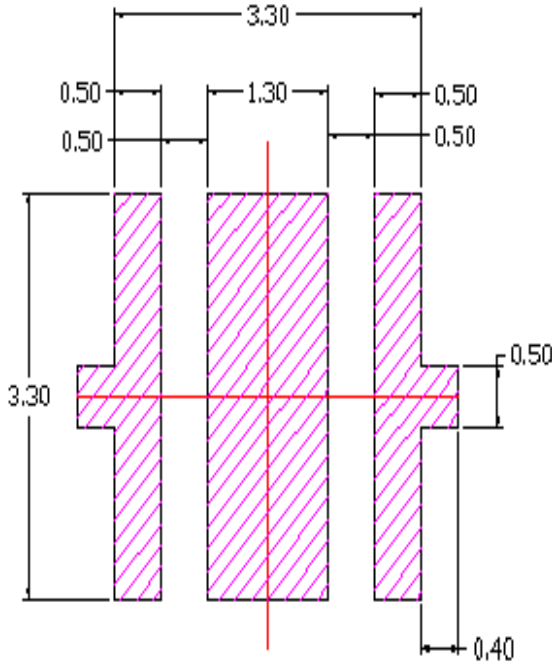

Recommended PCB Solder Pad

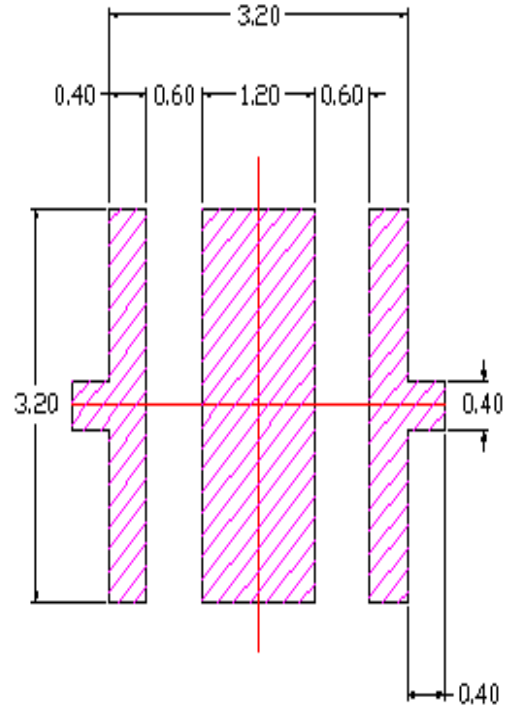

Recommended Stencil Pattern

### Notes :

- (1) All dimensions are in millimeters.
- (2) Scale : none
- (3) This drawing without tolerances are for reference only.
- (4) Undefined tolerance is  $\pm 0.1\text{mm}$ .

## Reflow Soldering Characteristics

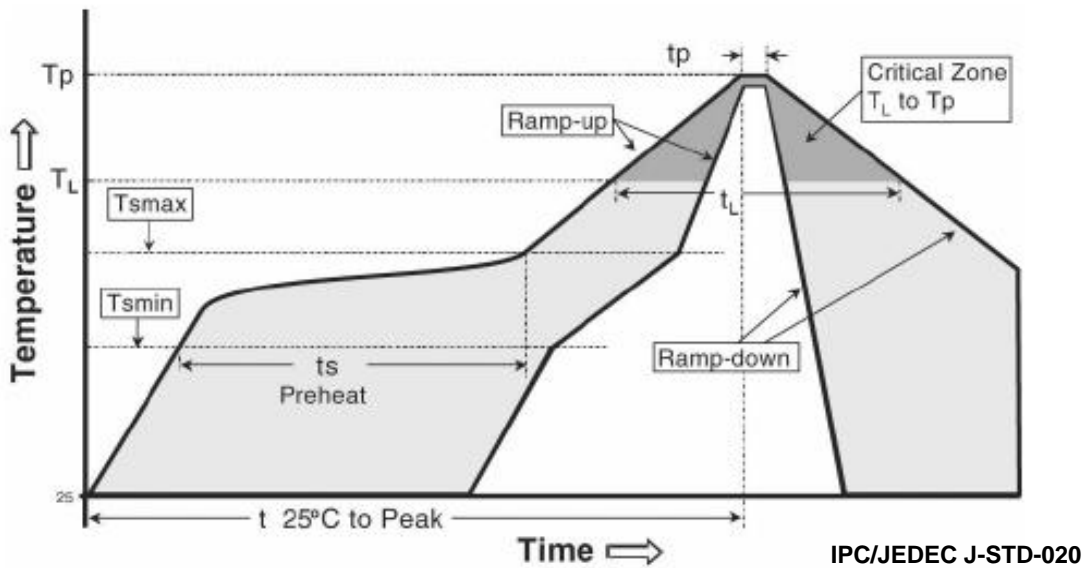
**Table 10.**

Profile Feature	Sn-Pb Eutectic Assembly	Pb-Free Assembly
Average ramp-up rate (T <sub>smax</sub> to T <sub>p</sub> )	3° C/second max.	3° C/second max.
Preheat - Temperature Min (T <sub>smin</sub> ) - Temperature Max (T <sub>smax</sub> ) - Time (T <sub>smin</sub> to T <sub>smax</sub> ) (t <sub>s</sub> )	100 °C 150 °C 60-120 seconds	150 °C 200 °C 60-180 seconds
Time maintained above: - Temperature (T <sub>L</sub> ) - Time (t <sub>L</sub> )	183 °C 60-150 seconds	217 °C 60-150 seconds
Peak Temperature (T <sub>p</sub> )	215 °C	260 °C
Time within 5°C of actual Peak Temperature (t <sub>p</sub> ) <sup>2</sup>	10-30 seconds	20-40 seconds
Ramp-down Rate	6 °C/second max.	6 °C/second max.
Time 25°C to Peak Temperature	6 minutes max.	8 minutes max.

### Caution

- (1) Reflow soldering is recommended not to be done more than two times. In the case of more than 24 hours passed soldering after first, LEDs will be damaged.
- (2) Repairs should not be done after the LEDs have been soldered. When repair is unavoidable, suitable tools must be used.
- (3) Die slug is to be soldered.
- (4) When soldering, do not put stress on the LEDs during heating.
- (5) After soldering, do not warp the circuit board.

## Handling of Silicone Resin for LEDs

- (1) During processing, mechanical stress on the surface should be minimized as much as possible. Sharp objects of all types should not be used to pierce the sealing compound.

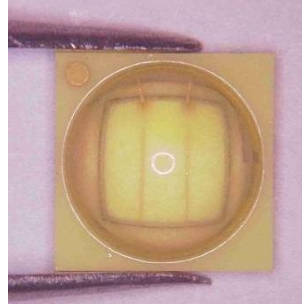
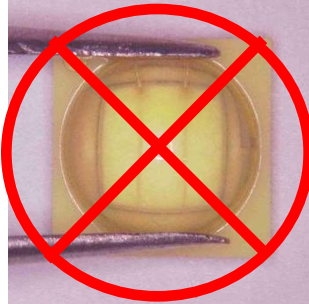

- (2) In general, LEDs should only be handled from the side. By the way, this also applies to LEDs without a silicone sealant, since the surface can also become scratched.
- (3) When populating boards in SMT production, there are basically no restrictions regarding the form of the pick and place nozzle, except that mechanical pressure on the surface of the resin must be prevented. This is assured by choosing a pick and place nozzle which is larger than the LED's reflector area.
- (4) Silicone differs from materials conventionally used for the manufacturing of LEDs. These conditions must be considered during the handling of such devices. Compared to standard encapsulants, silicone is generally softer, and the surface is more likely to attract dust. As mentioned previously, the increased sensitivity to dust requires special care during processing. In cases where a minimal level of dirt and dust particles cannot be guaranteed, a suitable cleaning solution must be applied to the surface after the soldering of components.
- (5) Seoul Semiconductor suggests using isopropyl alcohol for cleaning. In case other solvents are used, it must be assured that these solvents do not dissolve the package or resin. Ultrasonic cleaning is not recommended. Ultrasonic cleaning may cause damage to the LED.
- (6) Please do not mold this product into another resin (epoxy, urethane, etc) and do not handle this product with acid or sulfur material in sealed space.
- (7) Avoid leaving fingerprints on silicone resin parts.

## Precaution for Use

### (1) Storage

To avoid the moisture penetration, we recommend storing Z5 Series LEDs in a dry box with a desiccant. The recommended storage temperature range is 5 °C to 30 °C and a maximum humidity of RH50%.

### (2) Use Precaution after Opening the Packaging

Use proper SMD techniques when the LED is to be soldered dipped as separation of the lens may affect the light output efficiency.

Pay attention to the following:

- a. Recommend conditions after opening the package
  - Sealing / Temperature : 5 ~ 40 °C Humidity : less than RH30%
- b. If the package has been opened more than 1 year (MSL 2) or the color of the desiccant changes, components should be dried for 10-12hr at 60±5 °C

(3) Do not apply mechanical force or excess vibration during the cooling process to normal temperature after soldering.

(4) Do not rapidly cool device after soldering.

(5) Components should not be mounted on warped (non coplanar) portion of PCB.

(6) Radioactive exposure is not considered for the products listed here in.

(7) Gallium arsenide is used in some of the products listed in this publication. These products are dangerous if they are burned or shredded in the process of disposal. It is also dangerous to drink the liquid or inhale the gas generated by such products when chemically disposed of.

(8) This device should not be used in any type of fluid such as water, oil, organic solvent and etc. When washing is required, IPA (Isopropyl Alcohol) should be used.

(9) When the LEDs are in operation the maximum current should be decided after measuring the package temperature.

(10) LEDs must be stored properly to maintain the device. If the LEDs are stored for 3 months or more after being shipped from Seoul Semiconductor. A sealed container with a nitrogen atmosphere should be used for storage.

(11) The appearance and specifications of the product may be modified for improvement without notice.

(12) Long time exposure of sunlight or occasional UV exposure will cause lens discoloration.

## Precaution for Use

(13) VOCs (Volatile organic compounds) emitted from materials used in the construction of fixtures can penetrate silicone encapsulants of LEDs and discolor when exposed to heat and photonic energy. The result can be a significant loss of light output from the fixture. Knowledge of the properties of the materials selected to be used in the construction of fixtures can help prevent these issues.

(14) The slug is electrically isolated.

(15) Attaching LEDs, do not use adhesives that outgas organic vapor.

(16) The driving circuit must be designed to allow forward voltage only when it is ON or OFF. If the reverse voltage is applied to LED, migration can be generated resulting in LED damage.

(17) LEDs are sensitive to Electro-Static Discharge (ESD) and Electrical Over Stress (EOS). Below is a list of suggestions that Seoul Semiconductor purposes to minimize these effects.

### a. ESD (Electro Static Discharge)

Electrostatic discharge (ESD) is defined as the release of static electricity when two objects come into contact. While most ESD events are considered harmless, it can be an expensive problem in many industrial environments during production and storage. The damage from ESD to LEDs may cause the product to demonstrate unusual characteristics such as:

- Increase in reverse leakage current lowered turn-on voltage
- Abnormal emissions from the LED at low current

The following recommendations are suggested to help minimize the potential for an ESD event. One or more recommended work area suggestions:

- Ionizing fan setup
- ESD table/shelf mat made of conductive materials
- ESD safe storage containers

One or more personnel suggestion options:

- Antistatic wrist-strap
- Antistatic material shoes
- Antistatic clothes

Environmental controls:

- Humidity control (ESD gets worse in a dry environment)

## Precaution for Use

### b. EOS (Electrical Over Stress)

Electrical Over-Stress (EOS) is defined as damage that may occur when an electronic device is subjected to a current or voltage that is beyond the maximum specification limits of the device. The effects from an EOS event can be noticed through product performance like:

- Changes to the performance of the LED package  
(If the damage is around the bond pad area and since the package is completely encapsulated the package may turn on but flicker show severe performance degradation.)
- Changes to the light output of the luminaire from component failure
- Components on the board not operating at determined drive power

Failure of performance from entire fixture due to changes in circuit voltage and current across total circuit causing trickle down failures. It is impossible to predict the failure mode of every LED exposed to electrical overstress as the failure modes have been investigated to vary, but there are some common signs that will indicate an EOS event has occurred:

- Damaged may be noticed to the bond wires (appearing similar to a blown fuse)
- Damage to the bond pads located on the emission surface of the LED package  
(shadowing can be noticed around the bond pads while viewing through a microscope)
- Anomalies noticed in the encapsulation and phosphor around the bond wires.
- This damage usually appears due to the thermal stress produced during the EOS event.

### c. To help minimize the damage from an EOS event Seoul Semiconductor recommends utilizing:

- A surge protection circuit
- An appropriately rated over voltage protection device
- A current limiting device





## Company Information

### Published by

Seoul Semiconductor © 2013 All Rights Reserved.

### Company Information

Seoul Semiconductor ([www.SeoulSemicon.com](http://www.SeoulSemicon.com)) manufactures and packages a wide selection of light emitting diodes (LEDs) for the automotive, general illumination/lighting, Home appliance, signage and back lighting markets. The company is the world's fifth largest LED supplier, holding more than 10,000 patents globally, while offering a wide range of LED technology and production capacity in areas such as "nPola", "Acrich", the world's first commercially produced AC LED, and "Acrich MJT - Multi-Junction Technology" a proprietary family of high-voltage LEDs.

The company's broad product portfolio includes a wide array of package and device choices such as Acrich and Acirch2, high-brightness LEDs, mid-power LEDs, side-view LEDs, and through-hole type LEDs as well as custom modules, displays, and sensors.

### Legal Disclaimer

Information in this document is provided in connection with Seoul Semiconductor products. With respect to any examples or hints given herein, any typical values stated herein and/or any information regarding the application of the device, Seoul Semiconductor hereby disclaims any and all warranties and liabilities of any kind, including without limitation, warranties of non-infringement of intellectual property rights of any third party. The appearance and specifications of the product can be changed to improve the quality and/or performance without notice.