

Near UV LED - 405nm

NCOBLA series

CUN0MF9A

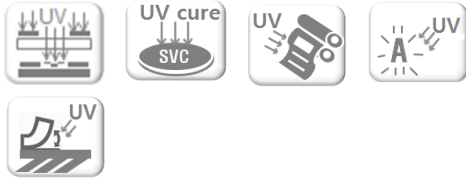

Product Brief

Description

- Super high power UV LED series are designed for high current operation and high power output applications.
- It incorporates state of the art high heat dissipation structure design and low thermal resistant material.
- NCOBL UV LED is ideal UV light source for curing, printing applications.

Features and Benefits

- Super high power output
- Designed for high current operation
- High thermal conductivity package
- Lead Free product
- RoHS compliant

Key Applications

- Lithography
- UV Curing
- Printing
- Inspection
- Adhesive

Table of Contents

Index

- Product Brief
- Table of Contents
- Performance Characteristics
- Characteristics Graph
- Binning Structure
- Mechanical Dimensions
- Electrical connection and heat sink assembly method
- NCOB series Packaging
- Product Nomenclature (Labeling Information)
- Handling for NCOBLA
- Precaution for Use
- Company Information

Performance Characteristics

Table 1. Electro - Optical characteristic at 9A

($T_a=25^\circ\text{C}$, RH=30%)

Parameter	Symbol	Value	Unit
Peak wavelength [1]	λ_p	403	nm
Radiant Flux[2]	Φ_e [3]	16,500	mW
Forward Voltage [4]	V_F	3.55	V
Spectrum Half Width	$\Delta \lambda$	14	nm
View Angle	$2\Theta_{1/2}$	115.5	deg.

Table 2. Absolute Maximum Rating

Parameter	Symbol	Value			Unit
		Min.	Typ.	Max.	
Forward Current	I_F	2	-	12	A
Junction Temperature	T_j	-	-	100	$^\circ\text{C}$
Storage Temperature	T_{stg}	- 40	-	100	$^\circ\text{C}$
Thermal resistance (J to B) [5]	$R\theta_{J-B}$	-	0.49	-	$^\circ\text{C/W}$

Notes :

1. Peak Wavelength Measurement tolerance : $\pm 3\text{nm}$
2. Radiant Flux Measurement tolerance : $\pm 10\%$
3. Φ_e is the Total Radiant Flux as measured with an integrated sphere.
4. Forward Voltage Measurement tolerance : $\pm 3\%$
5. $R\theta_{J-B}$ is the thermal resistance between chip junction to NCOBXX bottom.

Characteristics Graph

Fig 1. Spectrum, $T_a=25^\circ\text{C}$, $I_F=9\text{A}$

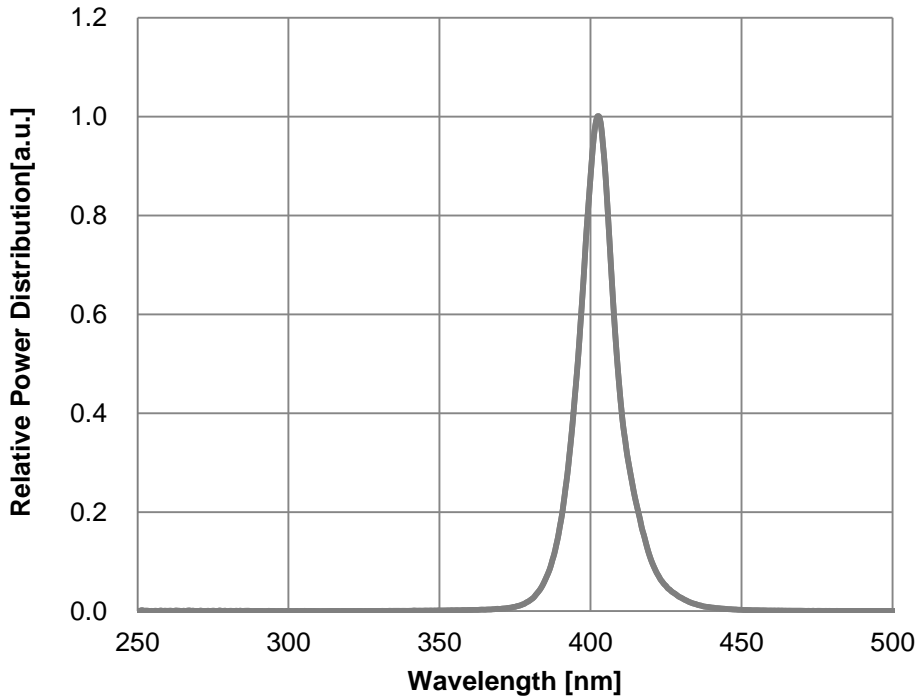
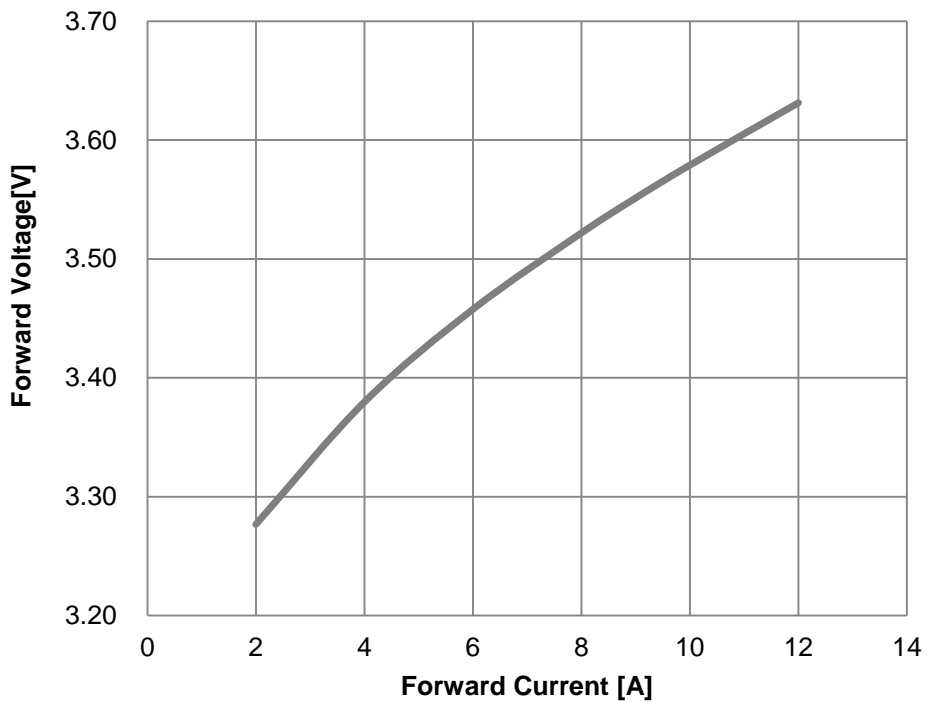

Fig 2. Forward Voltage vs. Forward Current, $T_a=25^\circ\text{C}$



Characteristics Graph

Fig 3. Forward Current vs. Relative Radiant Flux, $T_a=25^\circ\text{C}$

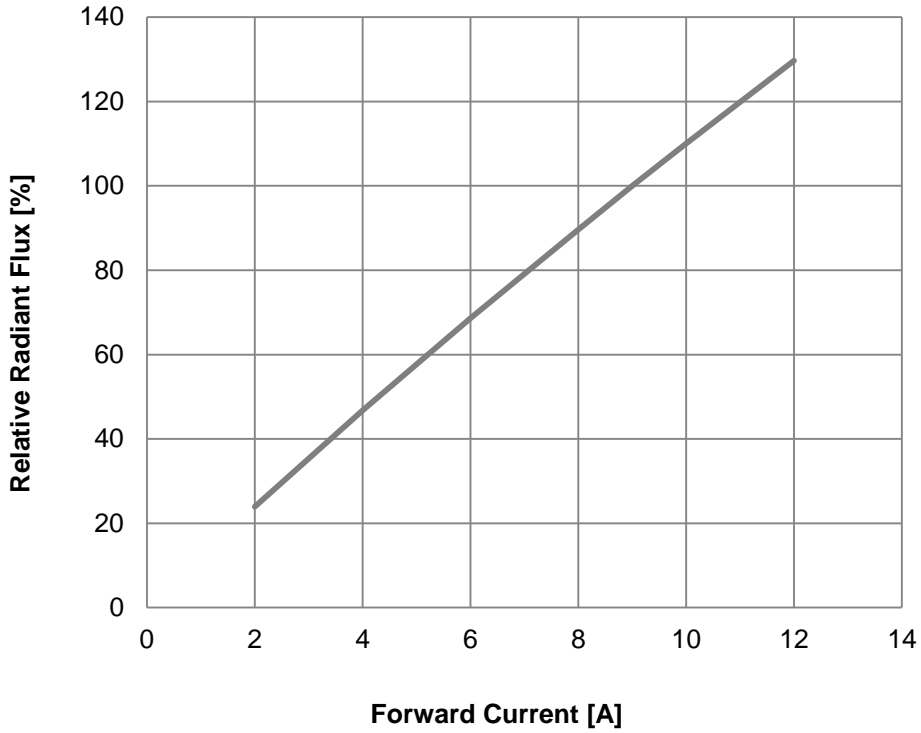
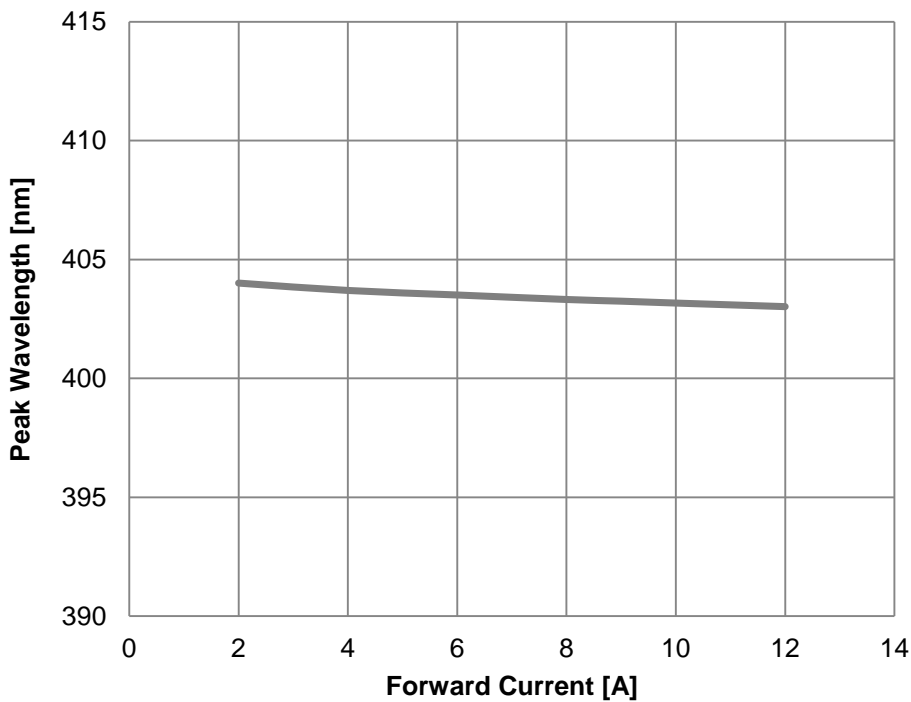

Fig 4. Forward Current vs. Peak Wavelength, $T_a=25^\circ\text{C}$



Characteristics Graph

Fig 5. Ambient Temperature vs. Relative Radiant Flux, $I_F=9A$

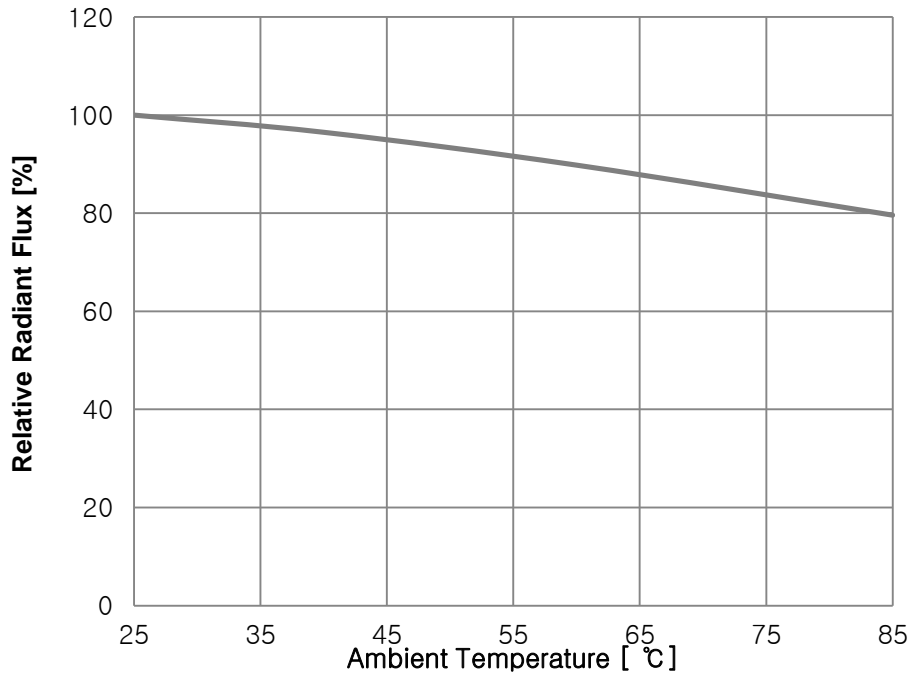
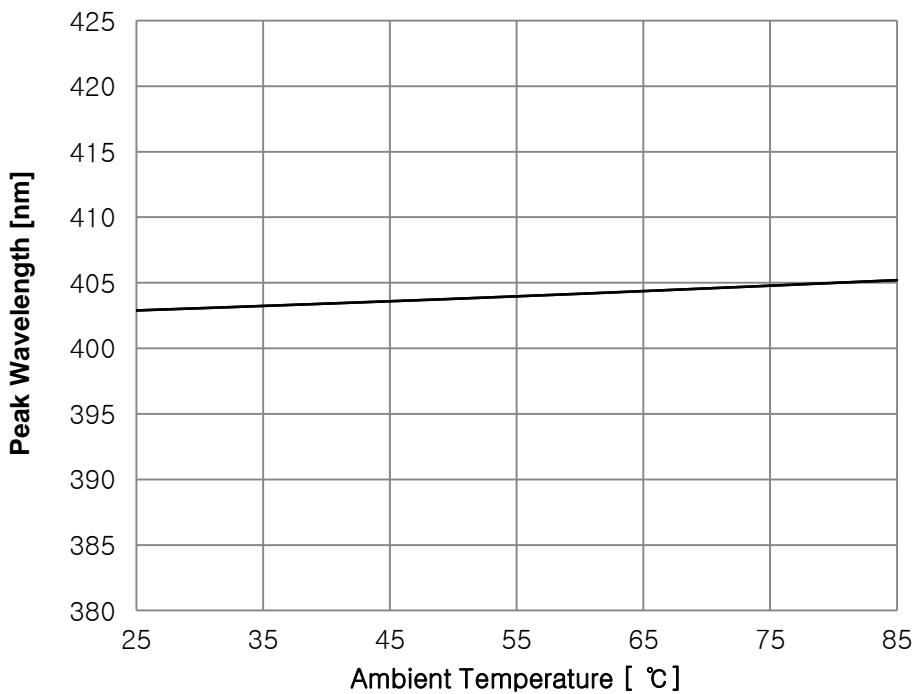

Fig 6. Ambient Temperature vs. Peak Wavelength, $I_F=9A$



Characteristics Graph

Fig 7. Ambient Temperature vs. Forward Voltage, $I_F=9A$

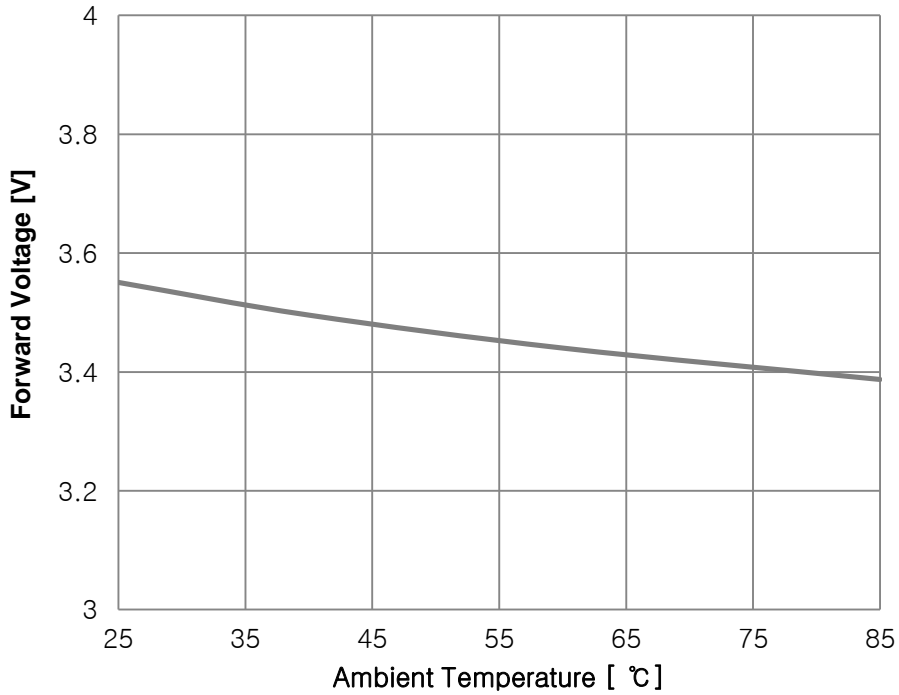
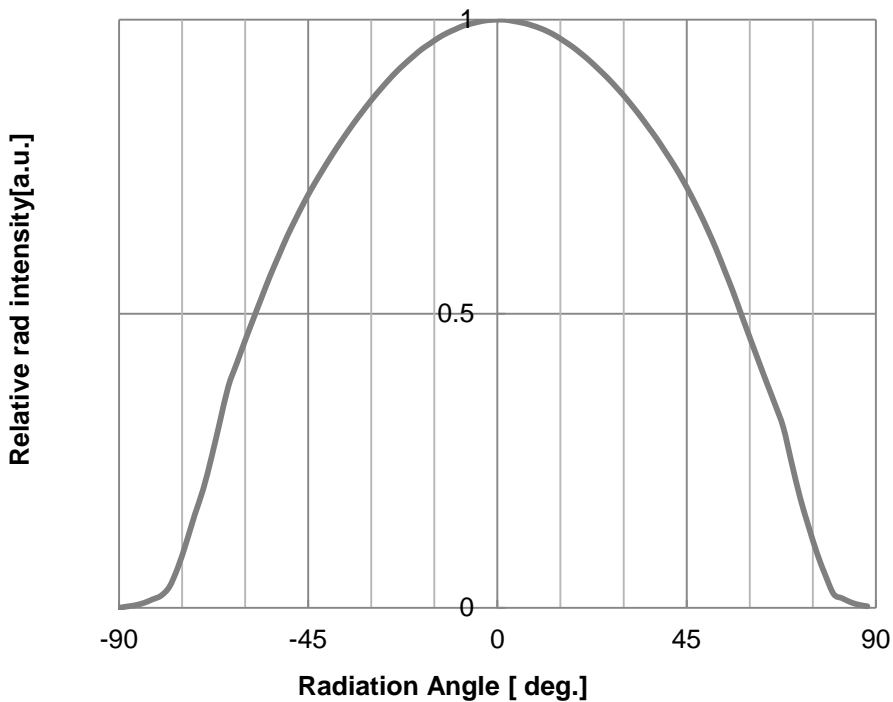

Fig 8. Typical Spatial Distribution, $I_F=2A$



Binning Structure

Table 3. Binning Structure , $I_f = 9A$

Y_1			Y_2Y_3			Y_4Y_5		
Wp [nm]			Radiant Flux [W]			Vf [V]		
BIN	MIN	MAX	BIN	MIN	MAX	BIN	MIN	MAX
p	400	410	V16	15	16	Z4	3.3	3.4
			V17	16	17	Z5	3.4	3.5
			V18	17	18	Z6	3.5	3.6
			V19	18	19	Z7	3.6	3.7
						Z8	3.7	3.8
						Z9	3.8	3.9

Table 4. Ranks :

Binning Code	Description	Unit
Y_1	Peak Wavelength	nm
Y_2Y_3	Radiant Flux	mW
Y_4Y_5	Forward Voltage	V

Notes :

1. Peak Wavelength Measurement tolerance : $\pm 3nm$
2. Radiant Flux Measurement tolerance : $\pm 10\%$
3. Forward Voltage Measurement tolerance : $\pm 3\%$

Mechanical Dimensions

Screw View

Top View

Side View

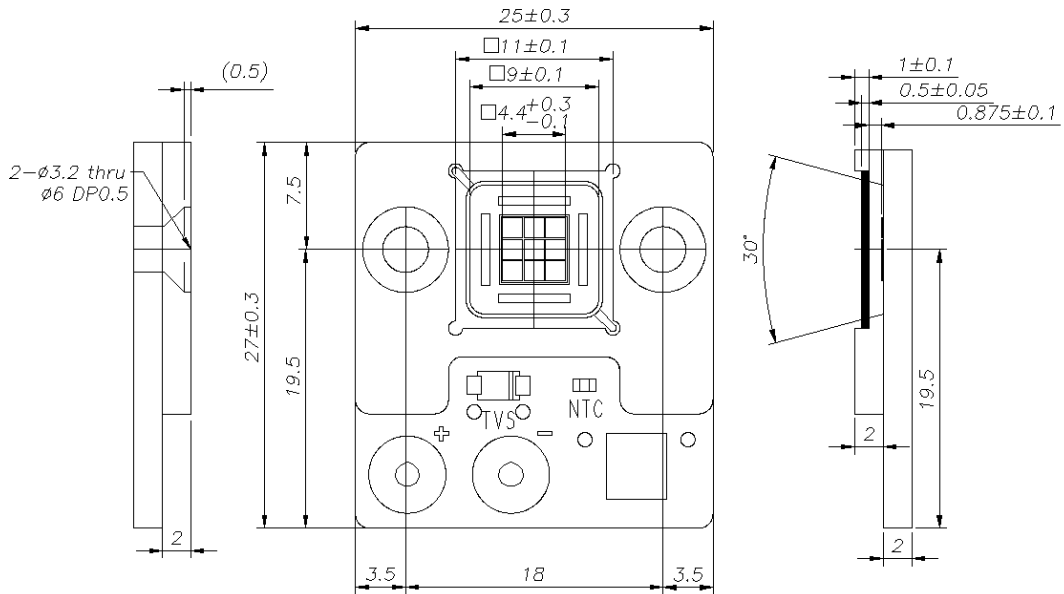

Circuit

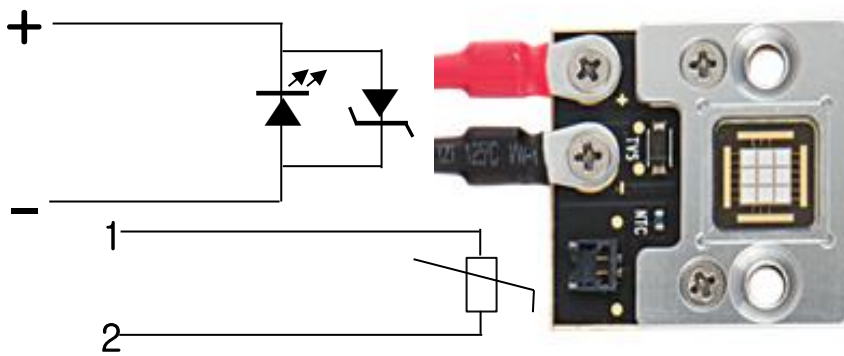

(1) All dimensions are in millimeters.

Electrical connection and heat sink assembly method

Electrical connection

- Information of the screws and wires for connecting the electrodes is shown below.
 - The screws : SFBJ2-3(MISUMI)
 - The ring terminal : JOR 1.5-3
 - The wire : UL AWG18 1007(RED/BLK)
- UL AWG18 1007 is suitable for 9A. Please use the optimum wire according to the current you use.
- If the screw is tilted, the screw hole of the board may be damaged.
- We recommend using a torque driver because screw holes on the board may be damaged if you connect the screws with excessive force.(using less than 11cN·m)

Heat sink assembly

- It is recommended to fasten the fixing holes with Ø3 size screw.

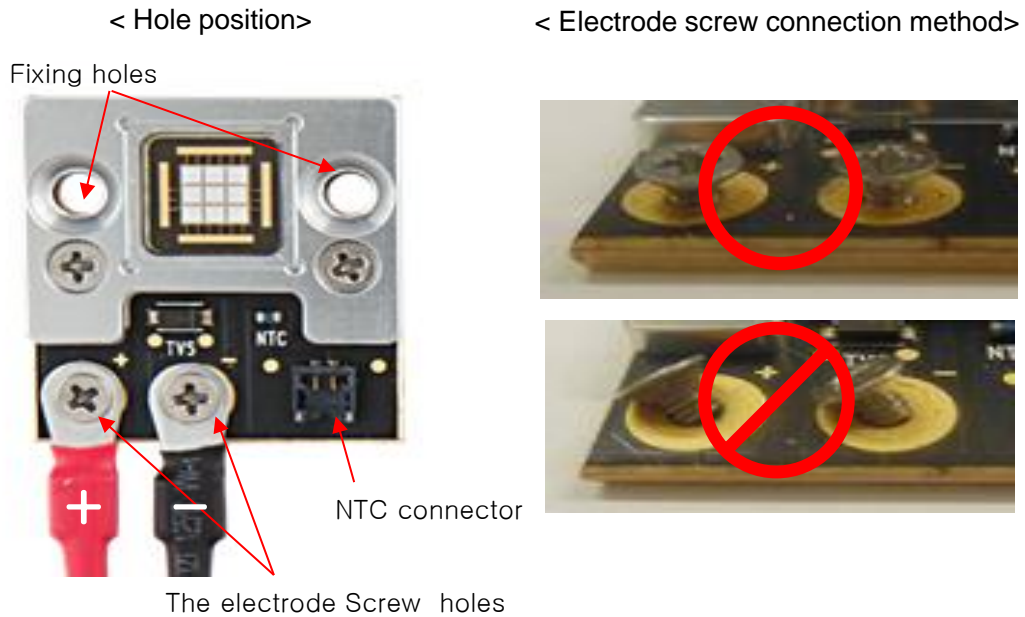

< Torque driver >

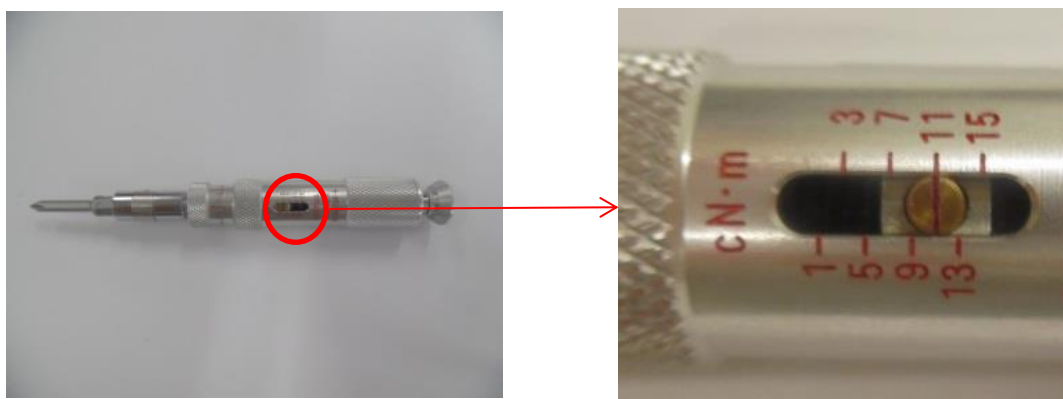

NCOB series packaging

1. Tray information

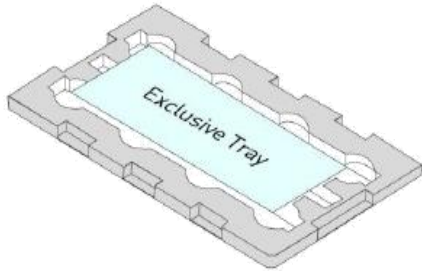

2. Tray stack and Banding

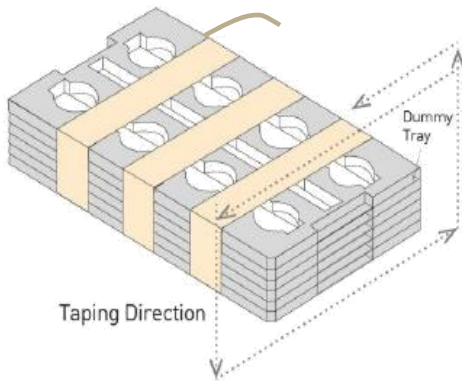

3. Sealing packing

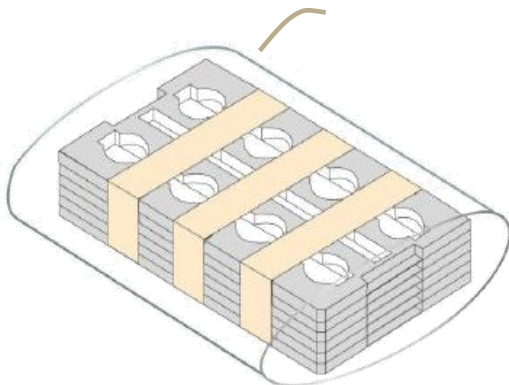

4. Box information & packing

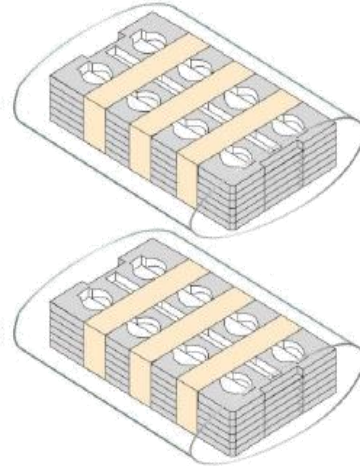

Product Nomenclature

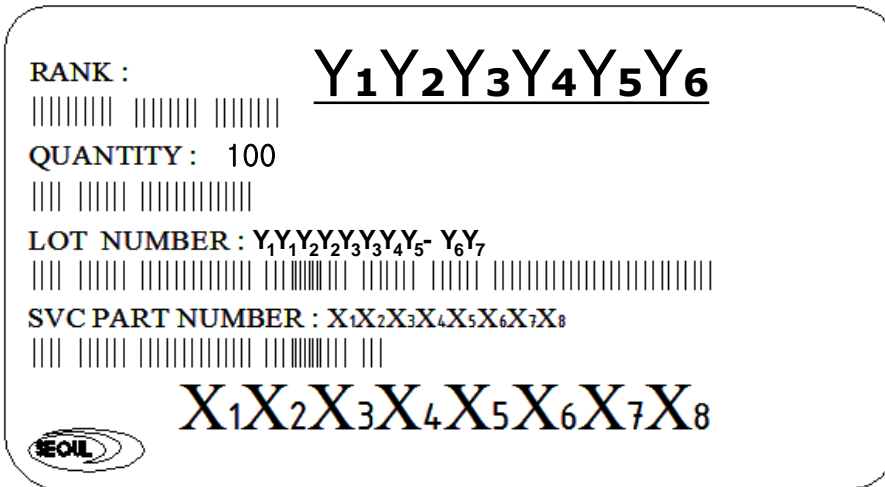
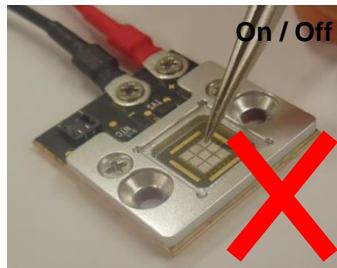

Table 5. Part Numbering System: X₁X₂X₃X₄X₅X₆X₇X₈

Part Number Code	Description	Part Number	Value
X ₁	Company	C	SVC
X ₂	UV LED	U	
X ₃ X ₄	Wavelength	N0	Near UV 405nm
X ₅	Package Series	M	NCOBL
X ₆	Lens type	A	Flat
X ₇	Chip Q'ty	1	9 chip
X ₈	Version	A	Ver0

Handling for NCOBLA

- (1) During processing, mechanical stress on the surface should be minimized as much as possible.
 - Sharp objects of all types should not be used to pierce the sealing compound.
- (2) In general, LEDs should only be handled from the side. If not, the surface can be scratched.
- (3) Glass can be damaged by force.
 - a. Be careful not to touch the lens with tweezers or sharp tools. The lens can be shattered or detach.
 - b. The product may break when it falls.



- (4) Process with care. NCOB series can be contaminated by foreign materials (particles, fume, gas, etc).
- (6) This device is not allowed to be used in any type of fluid such as water, oil, organic solvent, etc.
- (7) Please do not mold this product into another resin (epoxy, urethane, etc) and Do not handle this product with acid or sulfur material in sealed space.
- (8) Avoid leaving fingerprints on glass lens parts.
- (9) Do not touch NCOBXX during operating. There is a danger of electric shock and burns.

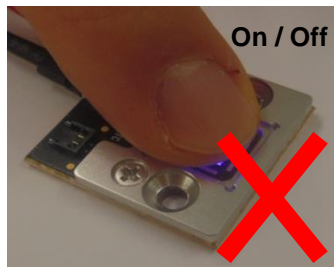

- (10) Do not hold the passive device (TVS, NTC and connector) with tools such as tweezers.

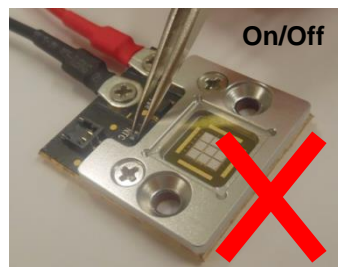
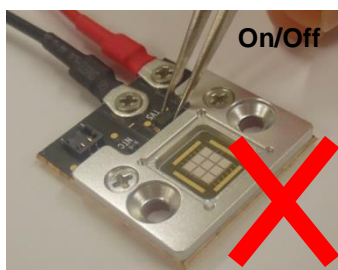

Handling for NCOBLA

- (11) There is a risk of electric shock. Do not touch the NCOBXX with conductive materials when it is operating.

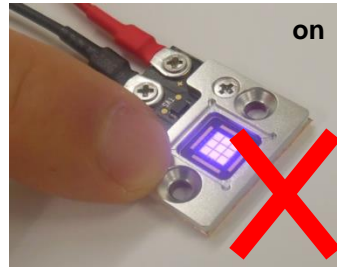
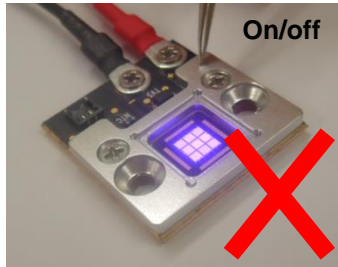

- (12) NTC information

- The thermistor used in NCOB series devices mounted on board is from DSC electronics Co., Ltd. The part number is DC103JU-1608(0603)
- Please refer to DSC website(<http://www.dscelec.co.kr>) for details on calculating thermistor temperature.
- The NTE header connector is mounted on the NCOBXX
- The connector of the thermistor(Header) is part number 78171-0002 of MOLEX.
- Receptacle housing requires harnessing with receptacle connector terminal and wires.
- Receptacle housing part number is 78172-0002 of MOLEX.
- Receptacle connector terminal part number is 78172-0410 of MOLEX.
- Please refer to MOLEX website(<http://www.molex.com>) for details.
- For more information on use of the NTC, please contact SVC directly.

< Header >

(78171-0002)



< terminal >

(78172-0410)

Top

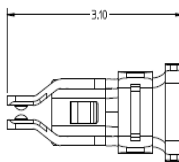

Side

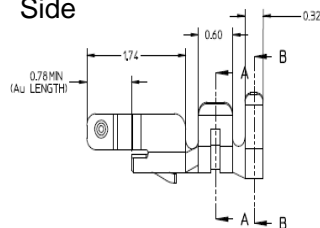

< Assembly >

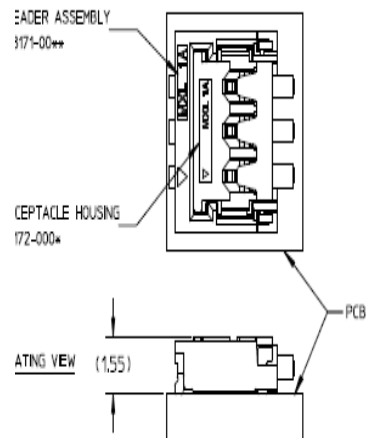

< Receptacle housing >

(78172-0002)



Handling for NCOBLA

Resistance-Temperature curve
NTC(DC103JU-1608(0603))

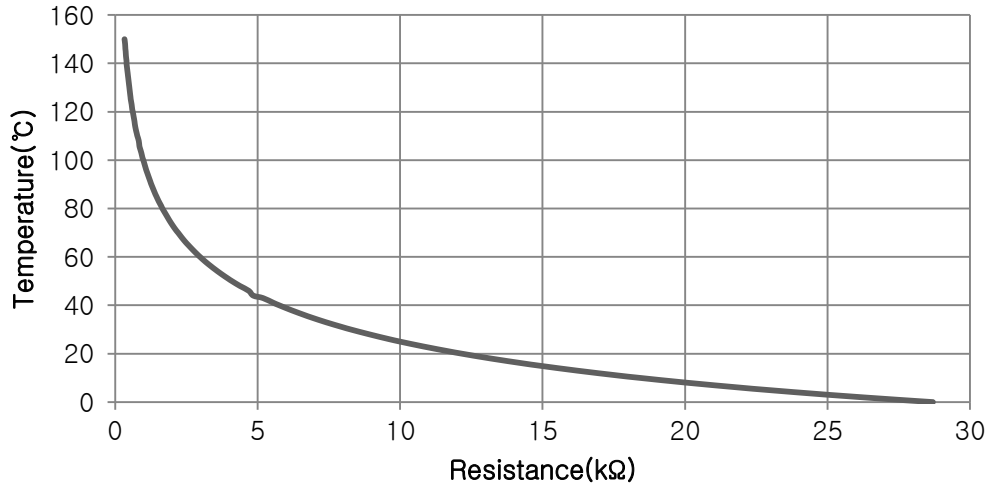

Precaution for Use

(1) Storage

To avoid the moisture penetration, we recommend storing LEDs in a dry box with a desiccant . The recommended storage temperature range is 5 °C to 30 °C and a maximum humidity of RH50%.

(2) Use Precaution after Opening the Packaging

Pay attention to the following:

a. Recommend conditions after opening the package

- Sealing / Temperature : 5 ~ 30 °C Humidity : less than RH60%

(3) Components should not be mounted on warped (non coplanar) portion of Heat sink.

(4) Radioactive exposure is not considered for the products listed here in.

(5) This device should not be used in any type of fluid such as water, oil, organic solvent and etc.

(6) When the LEDs are in operation the maximum current should be decided after measuring the package temperature.

(7) LEDs must be stored in a clean environment. We recommend LEDs to be stored in nitrogen-filled container.

(8) The appearance and specifications of the product may be modified for improvement without notice.

(9) VOCs (Volatile organic compounds) emitted from materials used in the construction of fixtures can penetrate silicone encapsulants of LEDs and discolor when exposed to heat and photonic energy. The result can be a significant loss of light output from the fixture. Knowledge of the properties of the materials selected to be used in the construction of fixtures can help prevent these issues.

(10) The bottom area of the NCOBXX is anode, so be careful of electric shock.

(11) When the NCOBXX is connected to the heat sink, the anode may flow to the reflector of the NCOB. Be careful of electric shock.

(12) In order to attach LEDs, outgassing organic vapor adhesives should be avoided.

(13) The driving circuit must be designed to allow forward voltage only when it is ON or OFF. If the reverse voltage is applied to LED, LED can be damaged from the migration.

Precaution for Use

(14) LEDs are sensitive to Electro-Static Discharge (ESD) and Electrical Over Stress (EOS). Below is a list of suggestions that Seoul Viosys proposes to minimize these effects.

a. ESD (Electro Static Discharge)

Electrostatic discharge (ESD) is defined as the release of static electricity when two objects come into contact. While most ESD events are considered harmless, it can be an expensive problem in many industrial environments during production and storage. The damage from ESD to LEDs may cause the product to demonstrate unusual characteristics such as:

- Increase in reverse leakage current lowered turn-on voltage
- Abnormal emissions from the LED at low current

The following recommendations are suggested to help minimize the potential for an ESD event.

Recommended work area.

- Ionizing fan setup
- ESD table/shelf mat made of conductive materials
- ESD safe storage containers

Recommended to wear ESD protection equipment.

- Antistatic wrist-strap
- Antistatic material shoes
- Antistatic clothes

Environmental controls:

- Humidity control (ESD gets worse in a dry environment)

Precaution for Use

b. EOS (Electrical Over Stress)

Electrical Over-Stress (EOS) is defined as damage that may occur when an electronic device is subjected to a current or voltage that is beyond the maximum specification limits of the device. The effects from an EOS event can be noticed through product performance like:

- Changes to the performance of the LED package
- Changes to the output power(radiant flux) from component failure
- Components on the board not operating at determined drive power

Failure of performance from entire fixture due to changes in circuit voltage and current across total circuit causes trickle down failures. It is impossible to predict the failure mode of every LED exposed to electrical overstress as the failure modes have been investigated to vary, but there are some common signs that will indicate an EOS event has occurred:

- Damaged may be noticed from the bond wires (appearing similar to a blown fuse)
- Damage to the bond pads located on the emission surface of the LED package (shadowing can be noticed around the bond pads while viewing through a microscope)
- Anomalies noticed in the encapsulation and phosphor around the bond wires.
- These damages usually occur due to the thermal stress produced during the EOS event.

c. To help minimize the damage from an EOS event Seoul Viosys recommends utilizing:

- A surge protection circuit
- An appropriately rated over voltage protection device
- A current limiting device

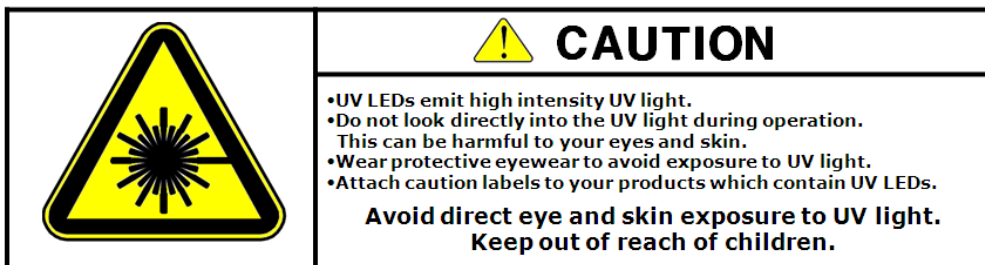

Company Information

Published by

Seoul Viosys © 2013 All Rights Reserved.

Company Information

Seoul Viosys (www.seoulviosys.com) manufactures light emitting diodes (LEDs) with a full range of UV wavelengths from UVC to UVA (under 400nm) for Industrial Curing, Air/Water Purification, Disinfection and Home appliance.

The company is one of the world leading UV LED supplier, holding more than 4,000 patents globally, while offering various kinds of LED technologies and application-solutions in High power UV LED, UV sensor, UV LED Lamp and variety of UV LED sourced Applications.

The company's broad product portfolio includes hybrid modules for unique applications such as UV disinfection, deodorization, UV purification as well as customized modules for your Application.

Legal Disclaimer

Information in this document is provided in connection with Seoul Viosys products. With respect to any examples or hints given herein, any typical values stated herein and/or any information regarding the application of the device, Seoul Viosys hereby disclaims any and all warranties and liabilities of any kind, including without limitation, warranties of non-infringement of intellectual property rights of any third party. The appearance and specifications of the product can be changed to improve the quality and/or performance without notice.